

97 mm

## San Ace B97



### General Specifications

- Material ..... Frame: Plastics (Flammability: UL94V-0),  
Impeller: Plastics (Flammability: UL94V-0)
- Expected Life ..... Refer to specifications (L10:Survival rate: 90% at 60°C,  
rated voltage, and continuously run in a free air state)
- Lead Wire ..... ⊕red ⊖black (Sensor) yellow (Control) brown  
(For models without PWM control function, there is no speed control wiring.)
- Storage Temperature ... -30°C to +70°C (Non-condensing)

## 97 mm × 33 mm

 (Mass : 190g) **9BMB type**

### Specifications

 The following nos. **have PWM controls and pulse sensors.**

Model No.	Rated Voltage [V]	Operating Voltage Range [V]	PWM duty cycle <sup>Note1)</sup> [%]	Rated Current [A]	Rated Input [W]	Rated Speed [min <sup>-1</sup> ]	Max. Airflow [m <sup>3</sup> /min] [CFM]	Max. Static Pressure [Pa] [inchH <sub>2</sub> O]	SPL [dB(A)]	Operating Temperature [°C]	Expected Life [h]
9BMB12P2K01	12	10.8 to 13.2	100	3.4	40.8	6,850	1.61 56.8	1,280 5.14	66	-20 to +70	40,000/60°C
9BMB12P2G01			100	1.8	21.6	5,750	1.34 47.3	760 3.050	61		
9BMB12P2S01		10.2 to 13.8	100	1.4	16.8	5,250	1.22 43.1	610 2.450	59		
9BMB12P2H01			100	1.1	13.2	4,850	1.11 39.2	490 1.968	57		
9BMB12P2F01			100	0.9	10.8	4,500	1.04 36.7	410 1.64	56		
9BMB24P2K01	24	21.6 to 26.4	100	1.62	38.88	6,850	1.61 56.8	1,280 5.14	66		
9BMB24P2G01			100	0.83	19.92	5,750	1.34 47.3	760 3.05	61		
9BMB24P2S01			100	0.7	16.8	5,250	1.22 43.1	610 2.450	59		
9BMB24P2H01			100	0.55	13.2	4,850	1.11 39.2	490 1.968	57		
9BMB24P2F01			100	0.45	10.8	4,500	1.04 36.7	410 1.640	56		

Note: Fan does not rotate when PWM duty cycle is 0%.

※PWM Frequency : 25kHz

### The following nos. have pulse sensors.

Model No.	Rated Voltage [V]	Operating Voltage Range [V]	Rated Current [A]	Rated Input [W]	Rated Speed [min <sup>-1</sup> ]	Max. Airflow [m <sup>3</sup> /min] [CFM]	Max. Static Pressure [Pa] [inchH <sub>2</sub> O]	SPL [dB(A)]	Operating Temperature [°C]	Expected Life [h]
9BMB12K201	12	7 to 13.2	3.4	40.8	6,850	1.61 56.8	1,280 5.14	66	-20 to +70	40,000/60°C
9BMB12G201			1.80	21.6	5,750	1.34 47.3	760 3.052	61		
9BMB12S201			1.40	16.8	5,250	1.22 43.1	610 2.450	59		
9BMB12H201			1.10	13.2	4,850	1.11 39.2	490 1.968	57		
9BMB12F201			0.90	10.8	4,500	1.04 36.7	410 1.647	56		
9BMB24K201	24	12 to 26.4	1.62	38.88	6,850	1.61 56.8	1,280 5.14	66		
9BMB24G201			0.83	19.9	5,750	1.34 47.3	760 3.052	61		
9BMB24S201			0.70	16.8	5,250	1.22 43.1	610 2.450	59		
9BMB24H201			0.55	13.2	4,850	1.11 39.2	490 1.968	57		
9BMB24F201			0.45	10.8	4,500	1.04 36.7	410 1.647	56		

Other sensor specifications are available as options. Please refer to the index (p. 501).

### Dimensions (unit: mm)

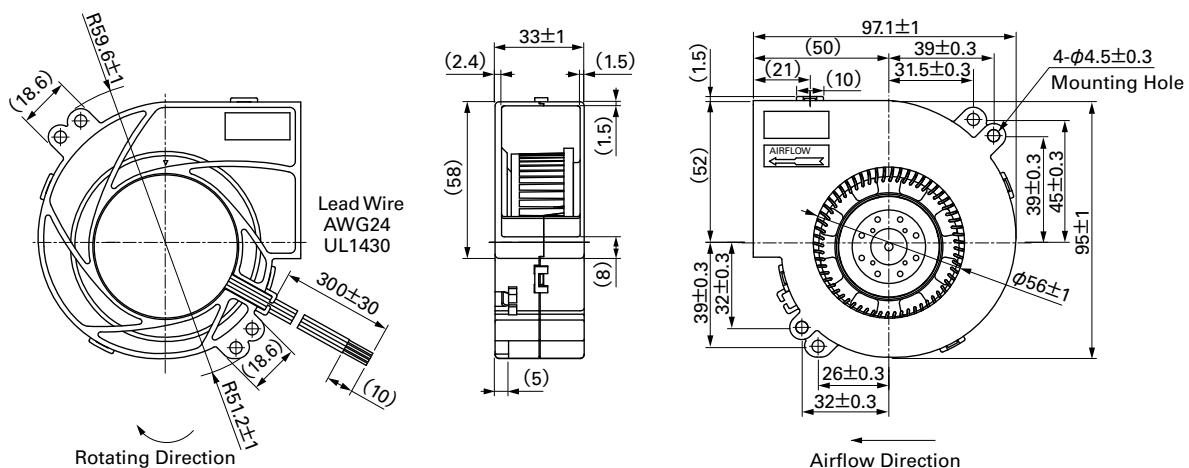
 (With PWM control function · With pulse sensor)

**Airflow - Static Pressure Characteristics**

**PWM Duty - Speed Characteristics Example**

**PWM Duty Cycle**

**Operating Voltage Range**

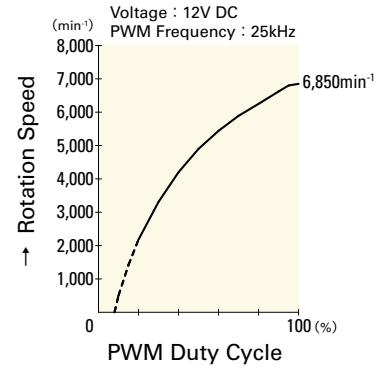
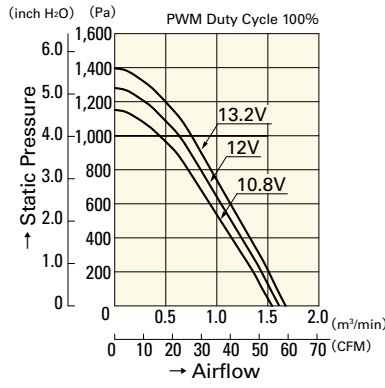
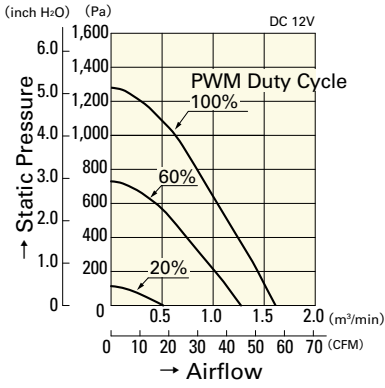

**9BMB12P2K01**

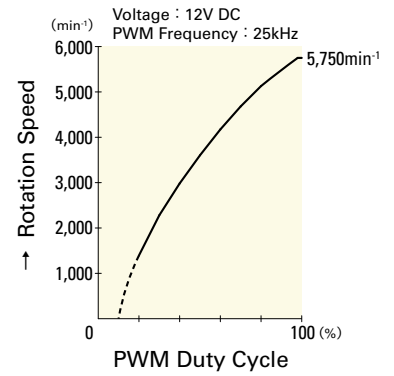
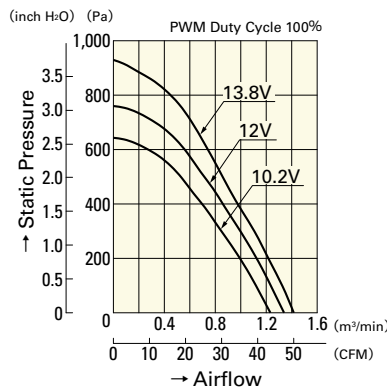
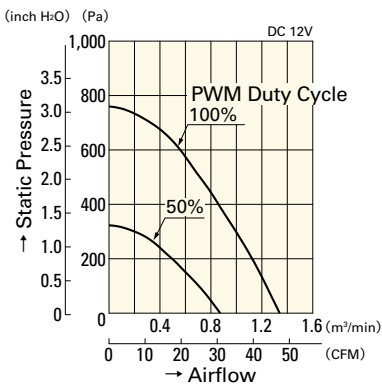

**9BMB12P2G01**

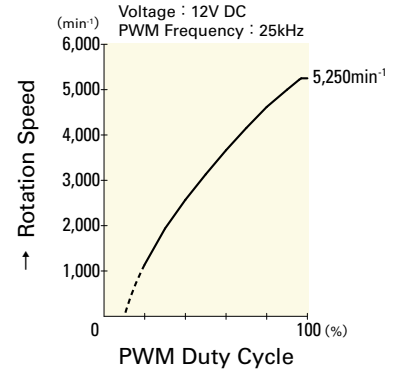
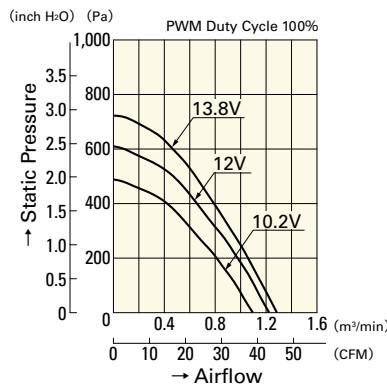
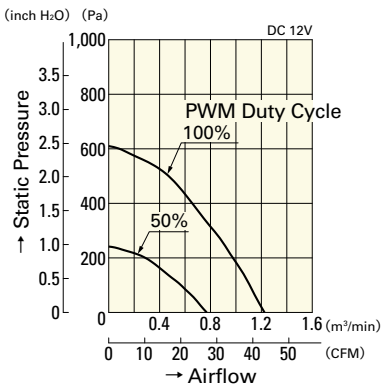

**9BMB12P2S01**

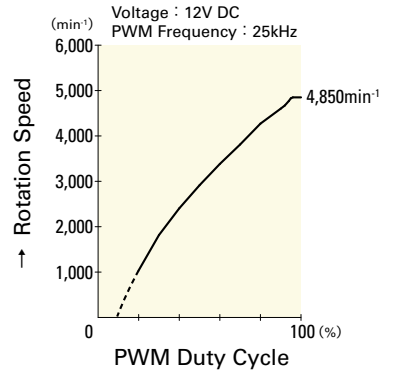
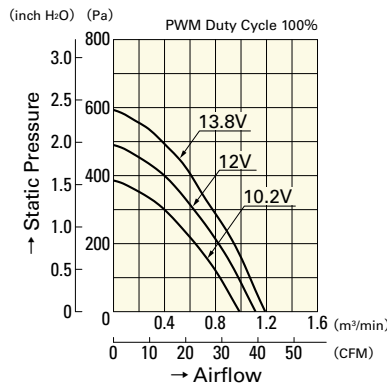
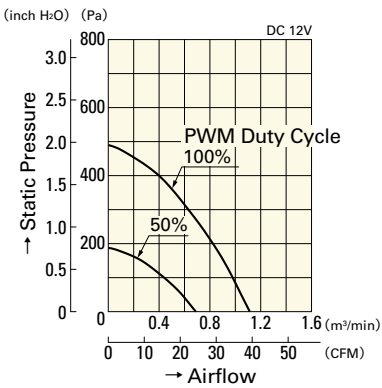

**9BMB12P2H01**

**DC Blower 97mm**

97mm

# San Ace B97

97mm × 33mm [Mass : 190g]

## Airflow - Static Pressure Characteristics

## PWM Duty - Speed Characteristics Example

### PWM Duty Cycle

### Operating Voltage Range

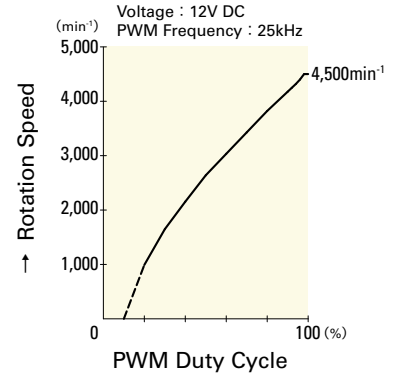
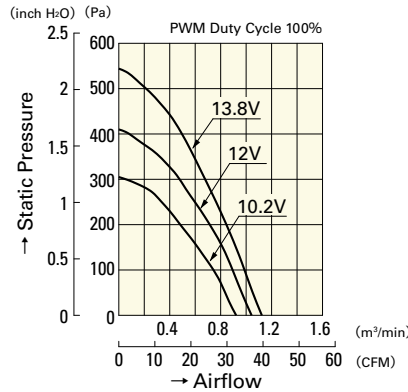
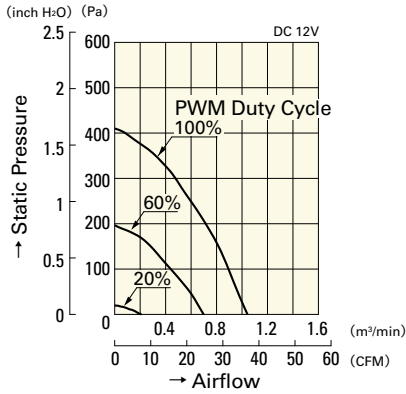

### 9BMB12P2F01

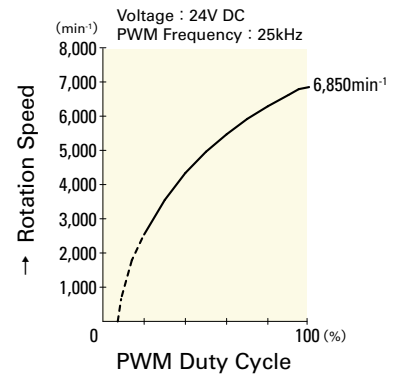
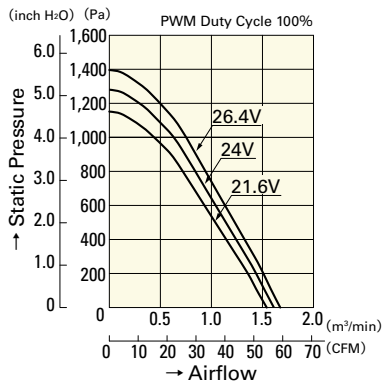
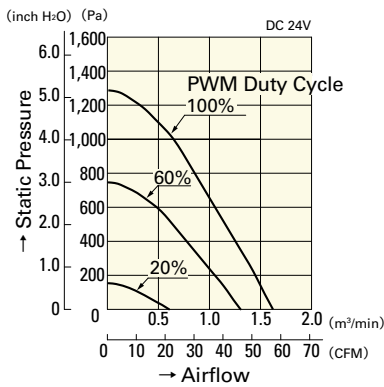

### 9BMB24P2K01

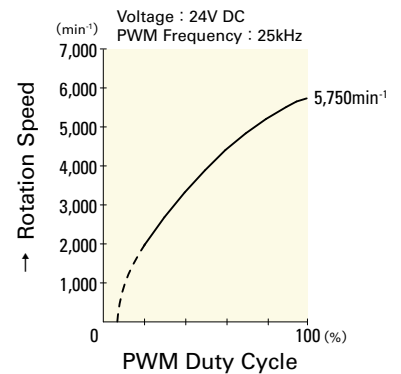
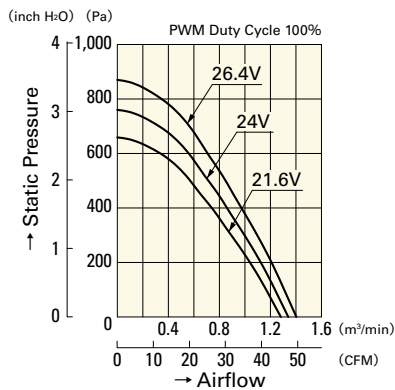
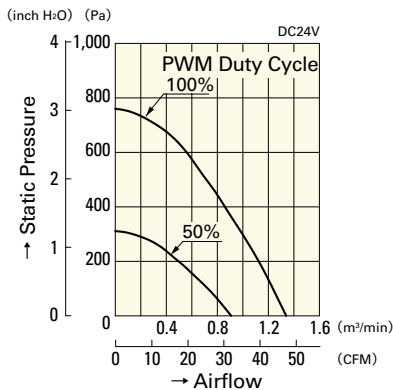

### 9BMB24P2G01

**Airflow - Static Pressure Characteristics**

**PWM Duty Cycle**

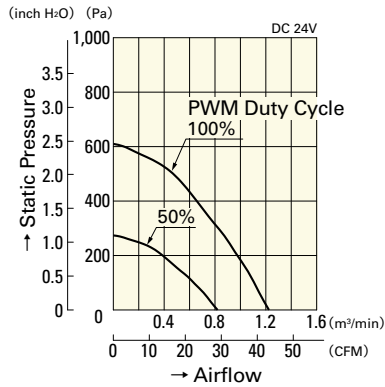

**Operating Voltage Range**

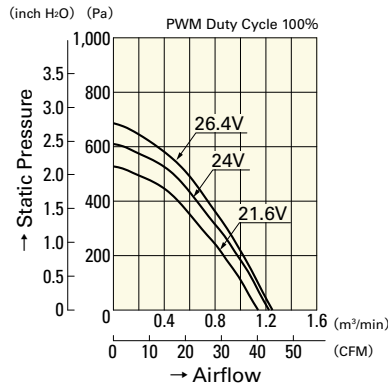

**PWM Duty - Speed Characteristics Example**

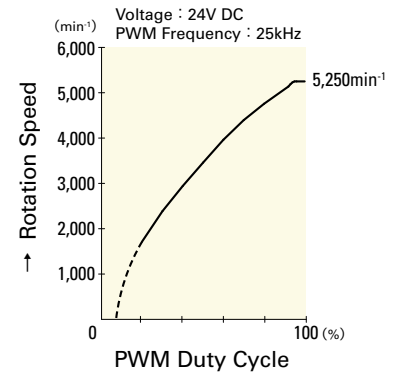

**9BMB24P2S01**

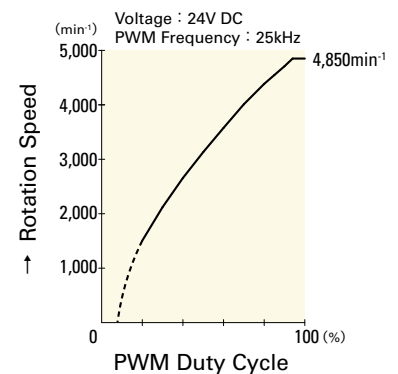
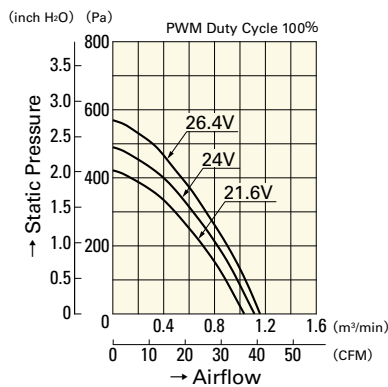
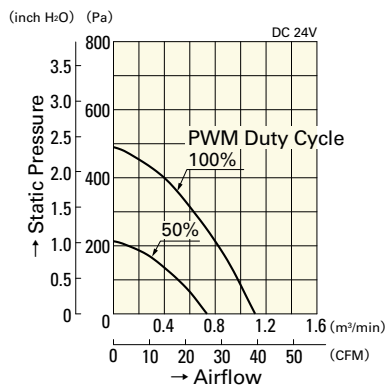

**9BMB24P2H01**

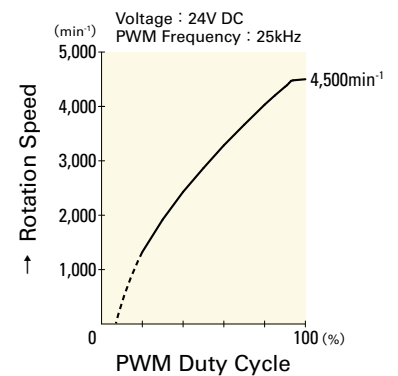
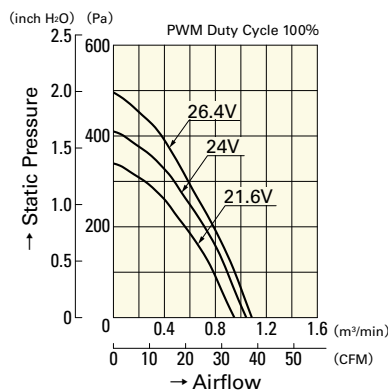
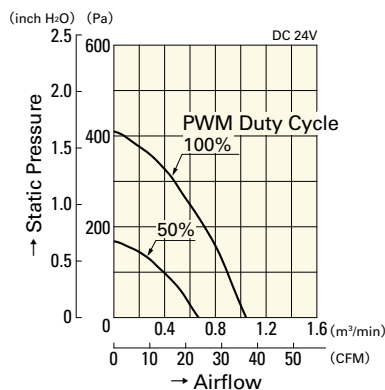

**9BMB24P2F01**

**DC**

**Blower 97mm**

97 mm

San Ace B97

97 mm × 33 mm (Mass : 190g)

## Airflow - Static Pressure Characteristics

## Operating Voltage Range

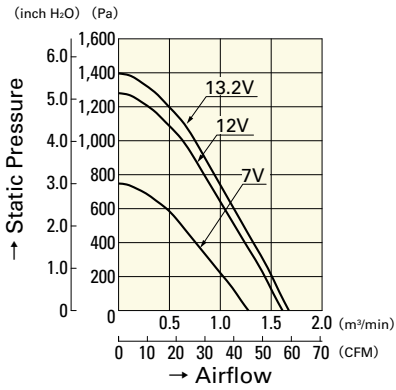

9BMB12K201

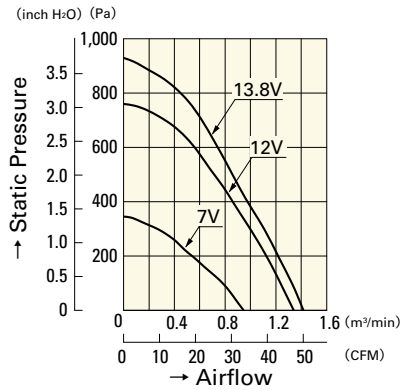

9BMB12G201

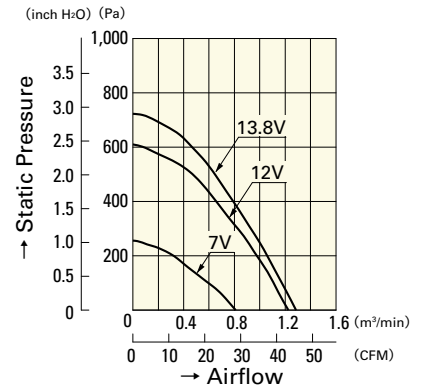

9BMB12S201

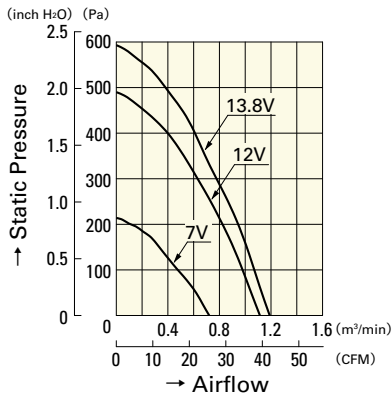

9BMB12H201

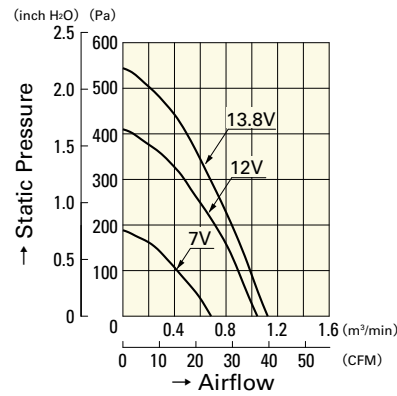

9BMB12F201

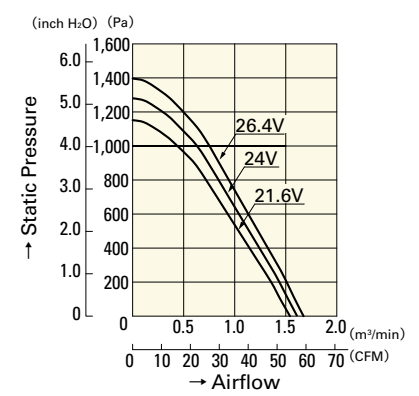

9BMB24K201

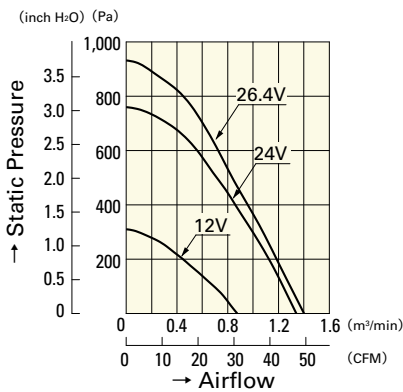

9BMB24G201

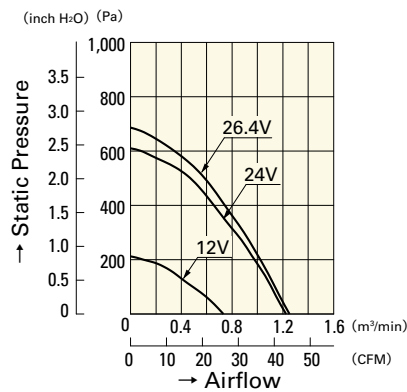

9BMB24S201

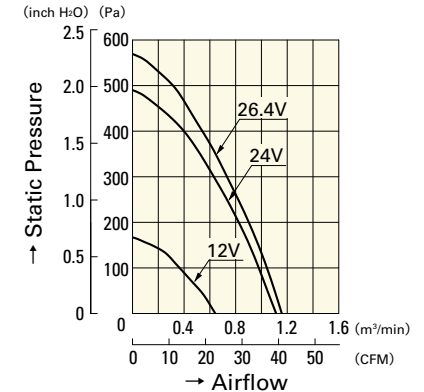

9BMB24H201

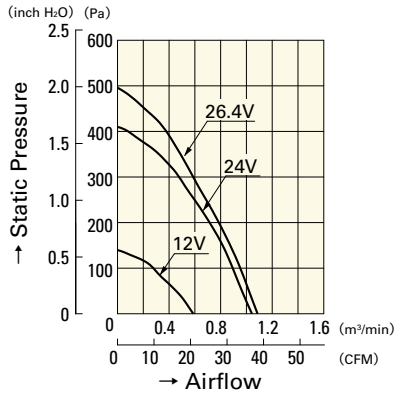

**9BMB24F201**

**Blower 97mm DC**

# Mouser Electronics

Authorized Distributor

Click to View Pricing, Inventory, Delivery & Lifecycle Information:

## Sanyo Denki:

[9BMB12F201](#) [9BMB12G201](#) [9BMB12P2F01](#) [9BMB12P2K01](#) [9BMB24P2G01](#) [9BMB24P2K01](#) [9BMB24G201](#)  
[9BMB24S201](#) [9BMB24F201](#) [9BMB12S201](#) [9BMB24H201](#) [9BMB12H201](#) [9BMB12P2H01](#) [9BMB12P2S01](#)  
[9BMB12P2G01](#) [9BMB24K201](#) [9BMB12K201](#) [9BMB24P2H01](#) [9BMB24P2S01](#) [9BMB24P2F01](#)