

# 60×60×25 mm

San Ace 60 9G type   



## General Specifications

- Material ..... Frame: Plastic (Flammability: UL 94V-0), Impeller: Plastic (Flammability: UL 94V-0)
- Expected life ..... See the table below. (L10 life: 90% survival rate for continuous operation in free air at 60°C, rated voltage) Expected life at 40°C is for reference only.
- Motor protection function ..... Locked rotor burnout protection, Reverse polarity protection  
For details, please refer to p. 614.
- Dielectric strength ..... 50/60 Hz, 500 VAC, for 1 minute (between lead wire conductors and frame)
- Insulation resistance ..... 10 MΩ min. at 500 VDC (between lead wire conductors and frame)
- Sound pressure level (SPL) ..... A-weighted sound pressure level (SPL) at 1 m away from the air inlet.
- Storage temperature ..... -30 to +70°C (Non-condensing)
- Lead wire ..... ⊕Red ⊖Black  Sensor  Yellow  Control  Brown
- Mass ..... 90 g

## Specifications

The models listed below **have ribs and a pulse sensor with PWM control**. For models without ribs, append "1" to the end of model numbers.

Model no.	Rated voltage [V]	Operating voltage range [V]	PWM duty cycle* [%]	Rated current [A]	Rated input [W]	Rated speed [min <sup>-1</sup> ]	Max. airflow [m <sup>3</sup> /min] [CFM]	Max. static pressure [Pa] [inchH <sub>2</sub> O]	SPL [dB (A)]	Operating temperature [°C]	Expected life [h]
9G0612P4S001	12	10.2 to 13.8	100	0.67	8.04	11000	1.4 49.4	300 1.2	53	-20 to +70	40000/60°C (70000/40°C)
			0	0.07	0.84	3300	0.42 14.8	27 0.11	19		
9G0612P4H001	12	10.2 to 13.8	100	0.5	6.0	9500	1.21 42.7	224 0.9	49		
			0	0.06	0.72	2850	0.36 12.7	20.2 0.08	18		
9G0624P4S001	24	20.4 to 27.6	100	0.34	8.16	11000	1.4 49.4	300 1.2	53		
			0	0.04	0.96	3300	0.42 14.8	27 0.11	19		
9G0624P4H001	24	20.4 to 27.6	100	0.25	6.0	9500	1.21 42.7	224 0.9	49		
			0	0.04	0.96	2850	0.36 12.7	20.2 0.08	18		
9G0648P4S001	48	36 to 72	100	0.18	8.64	11000	1.4 49.4	305 1.22	53		
			0	0.02	0.96	3300	0.42 14.8	27.4 0.11	19		

\* PWM frequency is 25 kHz. Models without ratings for 0% PWM duty cycle have zero speed at 0%. When control terminal is open, speed is the same as at 100% duty cycle.

Note 1: Sensor and control options are available for selection. Refer to the table on p. 641.

Note 2: The  mark indicates Short Lead Time Service applicable models. See p. 668 for details.

## Airflow - Static Pressure Characteristics / PWM Duty - Speed Characteristics Example

**9G0612P4S001** With pulse sensor with PWM control

PWM duty cycle

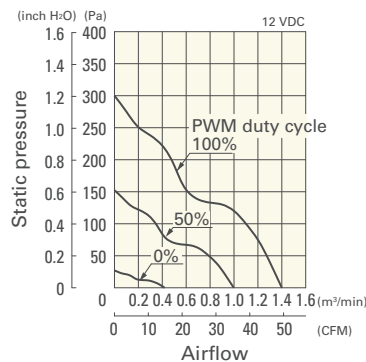

Operating voltage range

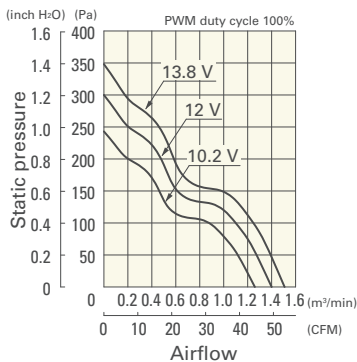

PWM duty - Speed characteristics example

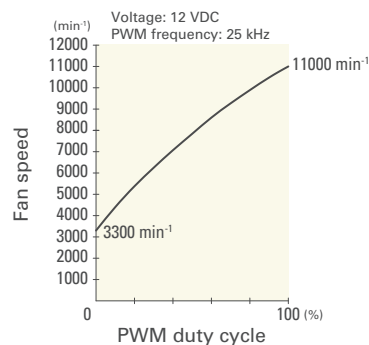

**9G0612P4H001** With pulse sensor with PWM control

PWM duty cycle

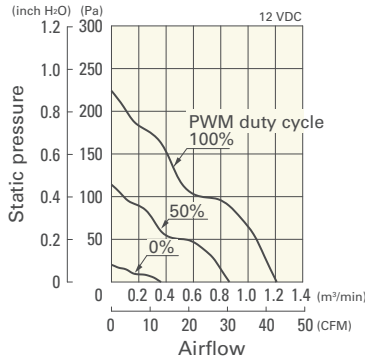

Operating voltage range

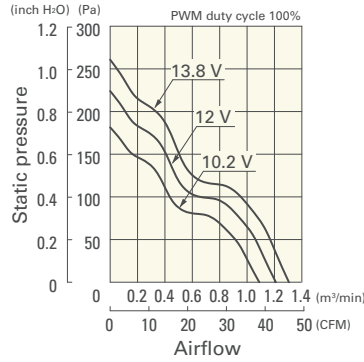

PWM duty - Speed characteristics example

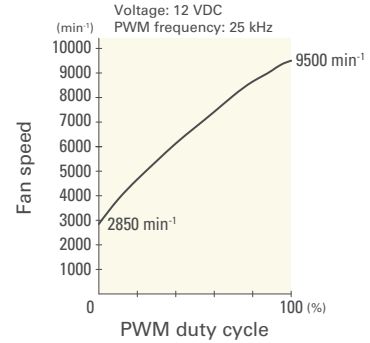

**9G0624P4S001** With pulse sensor with PWM control

PWM duty cycle

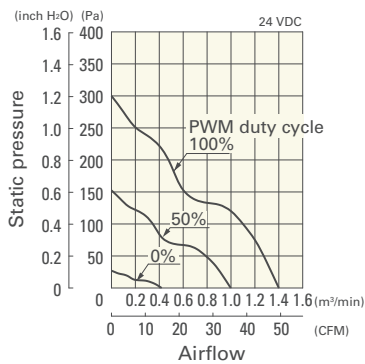

Operating voltage range

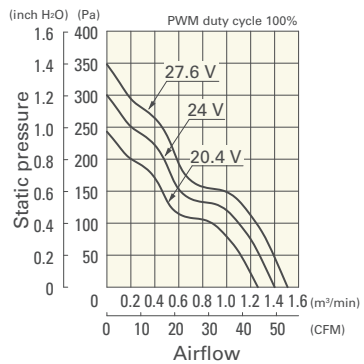

PWM duty - Speed characteristics example

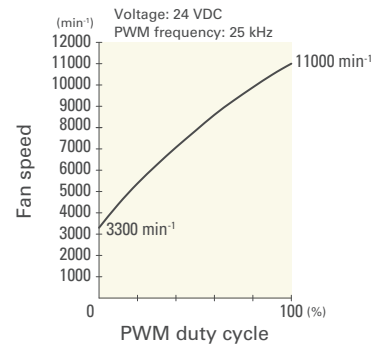

**9G0624P4H001** With pulse sensor with PWM control

PWM duty cycle

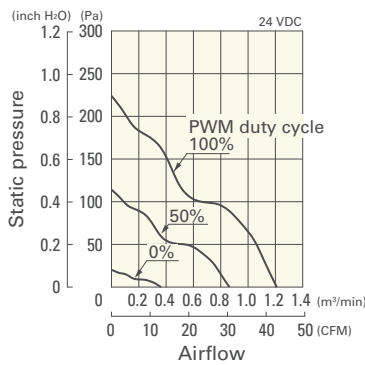

Operating voltage range

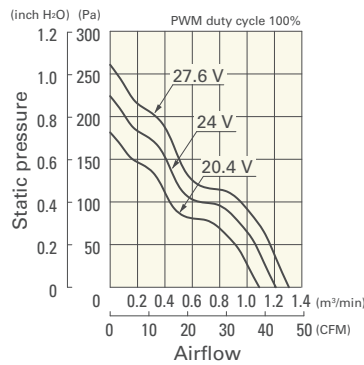

PWM duty - Speed characteristics example

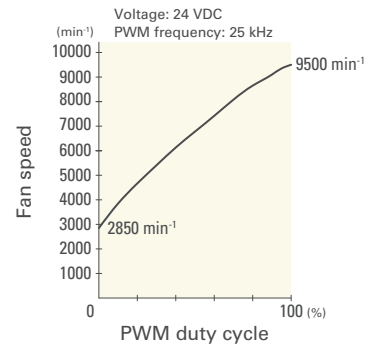

**9G0648P4S001** With pulse sensor with PWM control

PWM duty cycle

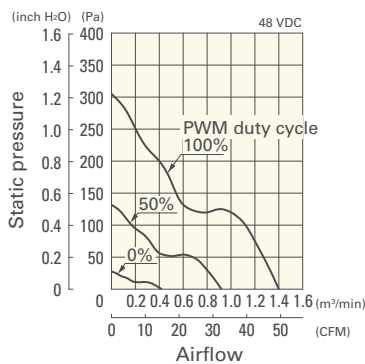

Operating voltage range

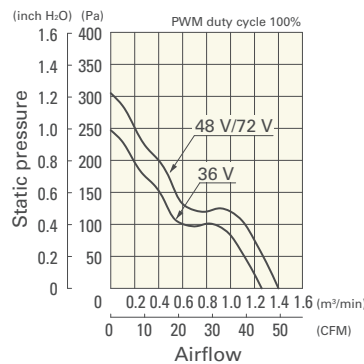

PWM duty - Speed characteristics example

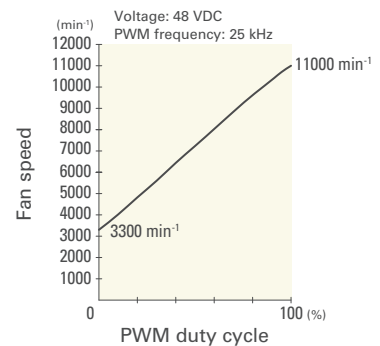

## Dimensions (unit: mm) (With ribs)

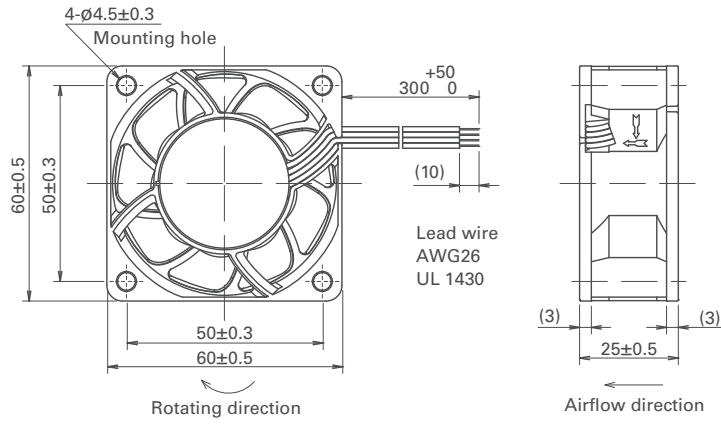

## Reference Dimensions of Mounting Holes and Vent Opening (unit: mm)

Inlet side, Outlet side

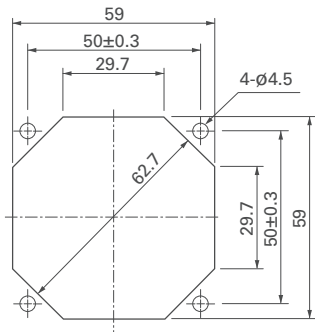

## Options

### Finger guards

page: p. 598

Model no.: 109-139E, 109-139H

### Resin finger guards

page: p. 605

Model no.: 109-1003G

### Resin filter kits

page: p. 606

Model no.: 109-1003F13 (13PPI), 109-1003F20 (20PPI),  
109-1003F30 (30PPI), 109-1003F40 (40PPI)