

92x92x32 mm

San Ace 92 9G type   



General Specifications

- Material Frame: Plastic (Flammability: UL 94V-0), Impeller: Plastic (Flammability: UL 94V-1)
- Expected life See the table below. (L10 life: 90% survival rate for continuous operation in free air at 60°C, rated voltage) Expected life at 40°C is for reference only.
- Motor protection function Locked rotor burnout protection, Reverse polarity protection For details, please refer to p. 614.
- Dielectric strength 50/60 Hz, 500 VAC, for 1 minute (between lead wire conductors and frame)
- Insulation resistance 10 MΩ min. at 500 VDC (between lead wire conductors and frame)
- Sound pressure level (SPL) A-weighted sound pressure level (SPL) at 1 m away from the air inlet.
- Storage temperature -30 to +70°C (Non-condensing)
- Lead wire ⊕Red ⊖Black or Blue Sensor Yellow
- Mass 170 g

Specifications

The models listed below **have ribs and a pulse sensor**. For models without ribs, append "1" to the end of model numbers.

| Model no. | Rated voltage [V] | Operating voltage range [V] | Rated current [A] | Rated input [W] | Rated speed [min ⁻¹] | Max. airflow [m ³ /min] [CFM] | Max. static pressure [Pa] [inchH ₂ O] | SPL [dB (A)] | Operating temperature [°C] | Expected life [h] |
|--------------|-------------------|-----------------------------|-------------------|-----------------|----------------------------------|--|--|--------------|----------------------------|----------------------------|
| ☞ 9G0912A201 | 12 | 10.2 to 13.8 | 0.58 | 6.96 | 4300 | 2.5 88.3 | 115 0.462 | 44 | -20 to +70 | 40000/60°C (70000/40°C) |
| ☞ 9G0912S201 | | | 0.38 | 4.56 | 3500 | 2.0 70.7 | 77 0.309 | 38 | | |
| ☞ 9G0912H201 | | | 0.23 | 2.76 | 2850 | 1.59 56.2 | 51 0.205 | 32 | | |
| ☞ 9G0912M201 | | | 0.13 | 1.56 | 2100 | 1.2 42.4 | 27 0.108 | 25 | | |
| ☞ 9G0924A201 | 24 | 20.4 to 27.6 | 0.3 | 7.2 | 4300 | 2.5 88.3 | 115 0.462 | 44 | -20 to +60 | |
| ☞ 9G0924S201 | | | 0.19 | 4.56 | 3500 | 2.0 70.7 | 77 0.309 | 38 | | |
| ☞ 9G0924H201 | | | 0.12 | 2.88 | 2850 | 1.59 56.2 | 51 0.205 | 32 | | |
| ☞ 9G0924M201 | | | 0.08 | 1.92 | 2100 | 1.2 42.4 | 27 0.108 | 25 | | |
| ☞ 9G0948A201 | 48 | 40.8 to 55.2 | 0.16 | 7.68 | 4300 | 2.5 88.3 | 115 0.462 | 44 | -20 to +70 | |
| ☞ 9G0948S201 | | | 0.11 | 5.28 | 3500 | 2.0 70.7 | 77 0.309 | 38 | | |
| ☞ 9G0948H201 | | | 0.08 | 3.84 | 2850 | 1.59 56.2 | 51 0.205 | 32 | | |
| ☞ 9G0948M201 | | | 0.05 | 2.4 | 2100 | 1.2 42.4 | 27 0.108 | 25 | | |

Note 1: Sensor and control options are available for selection. Refer to the table on pp. 641 to 642.

Note 2: The ☞ mark indicates Short Lead Time Service applicable models. See p. 668 for details.

Airflow - Static Pressure Characteristics

9G0912A201 With pulse sensor

Operating voltage range

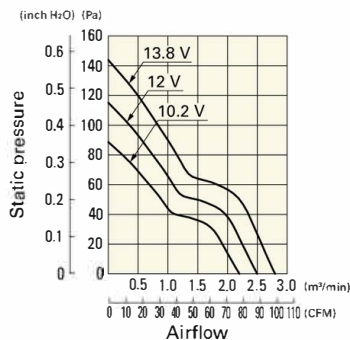

9G0912S201 With pulse sensor

Operating voltage range

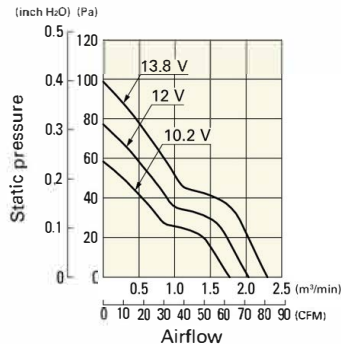

9G0912H201 With pulse sensor

Operating voltage range

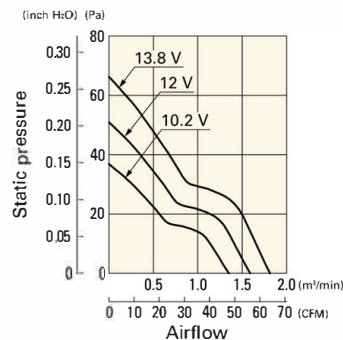

Airflow - Static Pressure Characteristics

DC Fan 92 mm sq.

9G0912M201 With pulse sensor

Operating voltage range

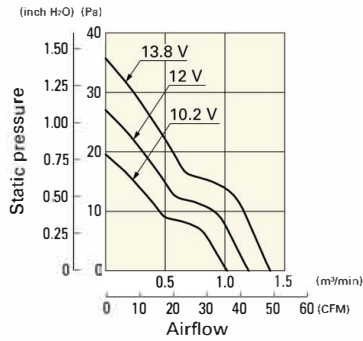

9G0924A201 With pulse sensor

Operating voltage range

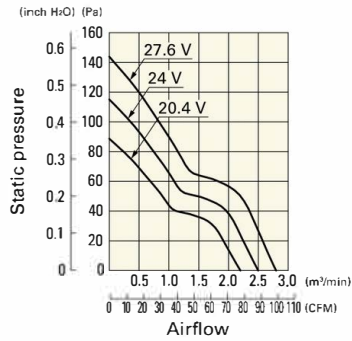

9G0924S201 With pulse sensor

Operating voltage range

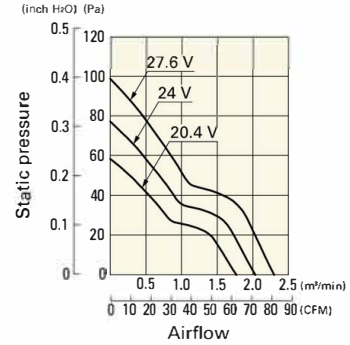

9G0924H201 With pulse sensor

Operating voltage range

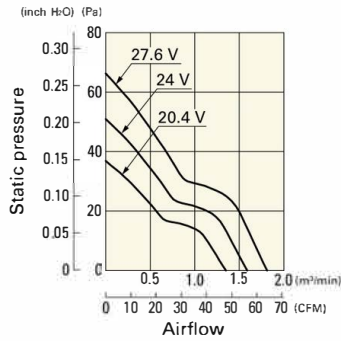

9G0924M201 With pulse sensor

Operating voltage range

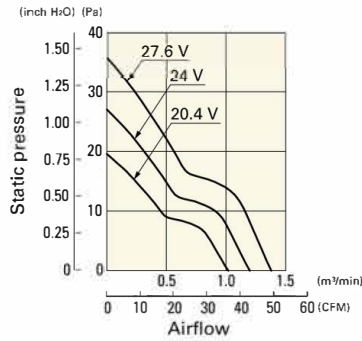

9G0948A201 With pulse sensor

Operating voltage range

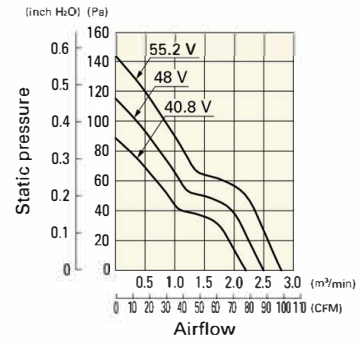

9G0948S201 With pulse sensor

Operating voltage range

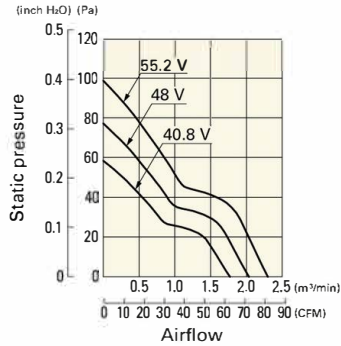

9G0948H201 With pulse sensor

Operating voltage range

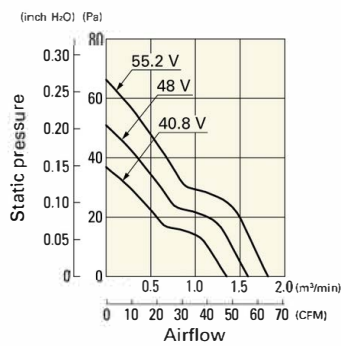

9G0948M201 With pulse sensor

Operating voltage range

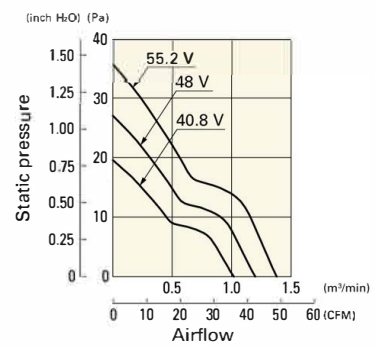

Dimensions (unit: mm) (With ribs)

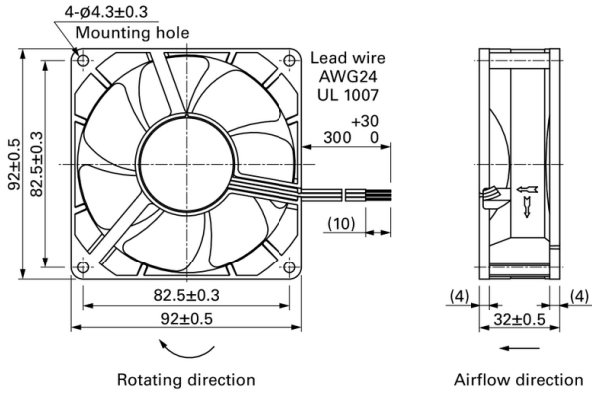

Reference Dimensions of Mounting Holes and Vent Opening (unit: mm)

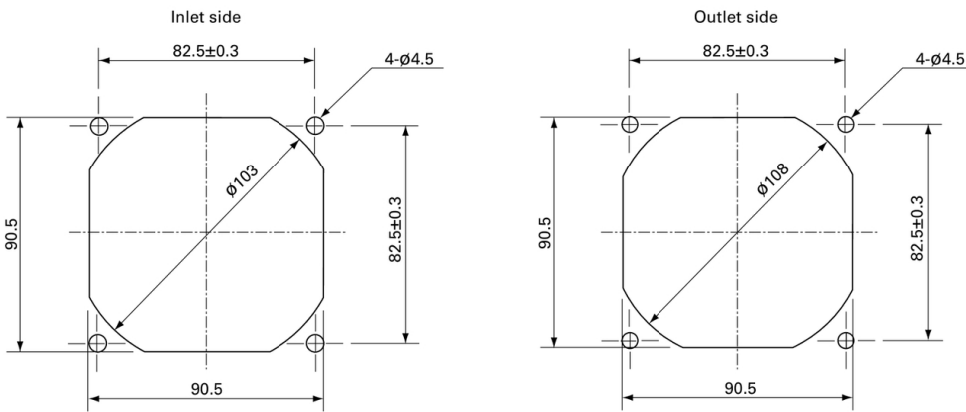

Options

Finger guards page: p. 598
 Model no.: 109-099E, 109-099H

Resin finger guards page: p. 605
 Model no.: 109-1001G

Resin filter kits page: p. 606
 Model no.: 109-1001F13 (13PPI), 109-1001F20 (20PPI),
 109-1001F30 (30PPI), 109-1001F40 (40PPI)