

40x40x28 mm

San Ace 40 9GA type Low Power Consumption Fan 



General Specifications

- Material Frame: Plastic (Flammability: UL 94V-0), Impeller: Plastic (Flammability: UL 94V-0)
- Expected life See the table below. (L10 life: 90% survival rate for continuous operation in free air at 60°C, rated voltage)
Expected life at 40°C is for reference only.
- Motor protection function Locked rotor burnout protection, Reverse polarity protection
For details, please refer to p. 614.
- Dielectric strength 50/60 Hz, 500 VAC, for 1 minute (between lead wire conductors and frame)
- Insulation resistance 10 MΩ min. at 500 VDC (between lead wire conductors and frame)
- Sound pressure level (SPL) A-weighted sound pressure level (SPL) at 1 m away from the air inlet.
- Storage temperature -30 to +70°C (Non-condensing)
- Lead wire ⊕Red ⊖Black (Sensor) Yellow (Control) Brown
(For models without PWM control, there is no speed control wiring.)
- Mass 53 g

Specifications

The models listed below **have ribs and a pulse sensor with PWM control**. For models without ribs, append "1" to the end of model numbers.

Model no.	Rated voltage [V]	Operating voltage range [V]	PWM duty cycle [%]	Rated current [A]	Rated input [W]	Rated speed [min ⁻¹]	Max. airflow [m ³ /min] [CFM]	Max. static pressure [Pa] [inchH ₂ O]	SPL [dB (A)]	Operating temperature [°C]	Expected life [h]	
9GA0412P3J01	12	10.8 to 13.2	100	0.49	5.88	18000	0.67 23.7	535 2.15	54	-20 to +70	40000/60°C (70000/40°C)	
			0	0.05	0.6	4500	0.16 5.7	33 0.13	22			
100			0.39	4.68	16500	0.61 21.5	450 1.81	53				
0			0.05	0.6	4500	0.16 5.7	33 0.13	22				
100			0.28	3.36	14500	0.54 19.1	347 1.39	50				
0			0.04	0.48	3500	0.13 4.6	20 0.08	17				
9GA0412P3H01		24	21.6 to 26.4	100	0.21	2.52	12500	0.46 16.2	258 1.04			47
				0	0.04	0.48	3500	0.13 4.6	20 0.08			17
100				0.27	6.48	18000	0.67 23.7	535 2.15	54			
100				0.22	5.28	16500	0.61 21.5	450 1.81	53			
100				0.16	3.84	14500	0.54 19.1	347 1.39	50			
100				0.11	2.64	12500	0.46 16.2	258 1.04	47			

* PWM frequency is 25 kHz. Models without ratings for 0% PWM duty cycle have zero speed at 0%. When control terminal is open, speed is the same as at 100% duty cycle.

The models listed below **have ribs and a pulse sensor**. For models without ribs, append "1" to the end of model numbers.

Model no.	Rated voltage [V]	Operating voltage range [V]	Rated current [A]	Rated input [W]	Rated speed [min ⁻¹]	Max. airflow [m ³ /min] [CFM]	Max. static pressure [Pa] [inchH ₂ O]	SPL [dB (A)]	Operating temperature [°C]	Expected life [h]
9GA0412A301	12	10.8 to 13.2	0.13	1.56	10500	0.38 13.4	182 0.73	43	-10 to +70	40000/60°C (70000/40°C)

Note 1: Sensor and control options are available for selection. Refer to the table on p. 642.

Note 2: The  mark indicates Short Lead Time Service applicable models. See p. 668 for details.

Airflow - Static Pressure Characteristics / PWM Duty - Speed Characteristics Example

9GA0412P3J01 With pulse sensor with PWM control

PWM duty cycle

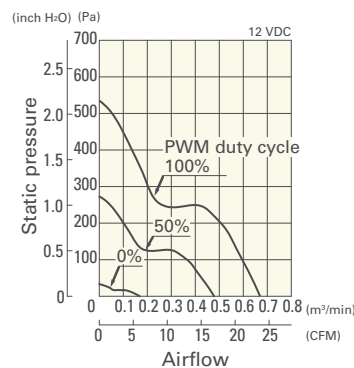

Operating voltage range

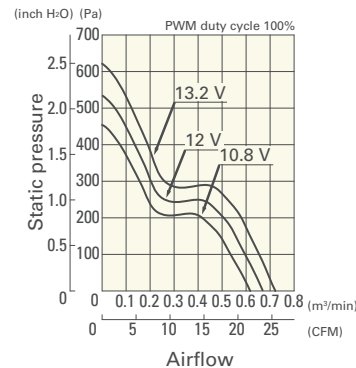

PWM duty - Speed characteristics example

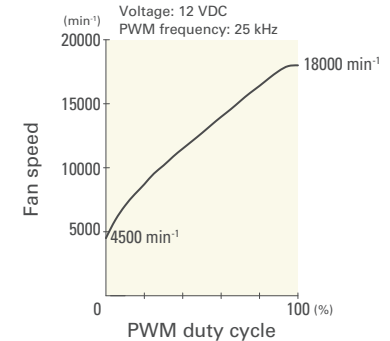

9GA0412P3G01 With pulse sensor with PWM control

PWM duty cycle

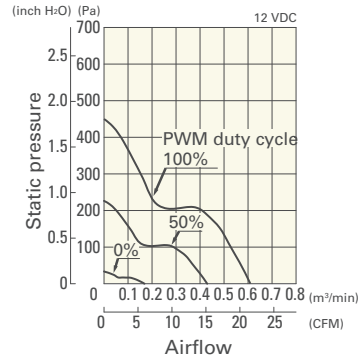

Operating voltage range

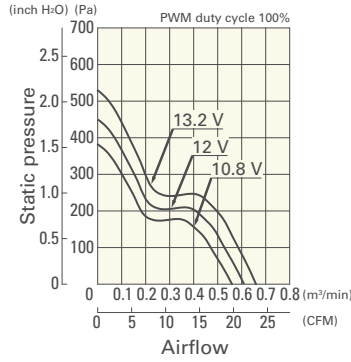

PWM duty - Speed characteristics example

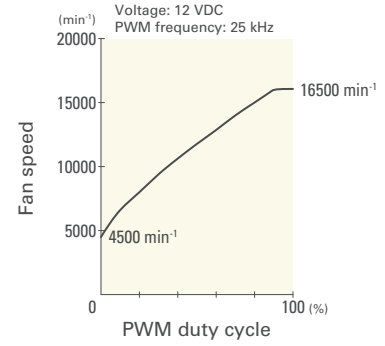

9GA0412P3H01 With pulse sensor with PWM control

PWM duty cycle

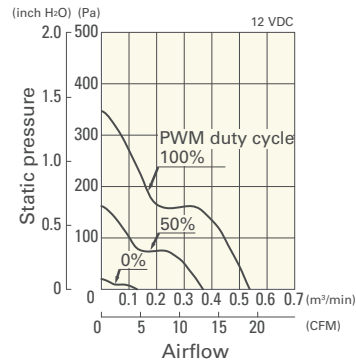

Operating voltage range

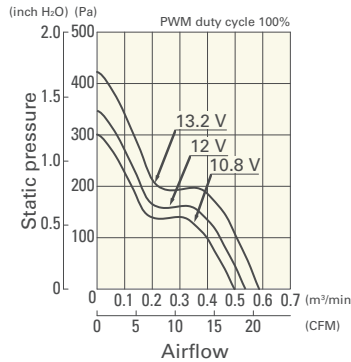

PWM duty - Speed characteristics example

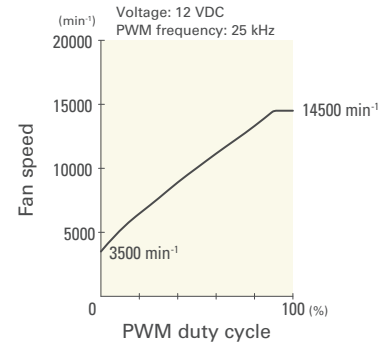

9GA0412P3M01 With pulse sensor with PWM control

PWM duty cycle

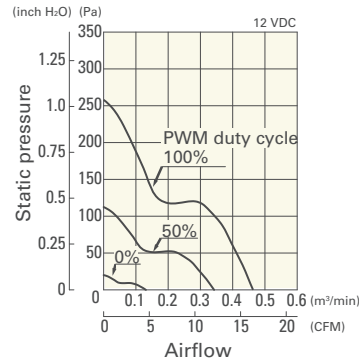

Operating voltage range

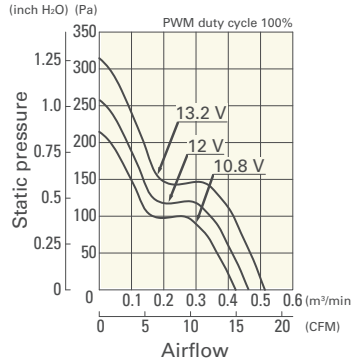

PWM duty - Speed characteristics example

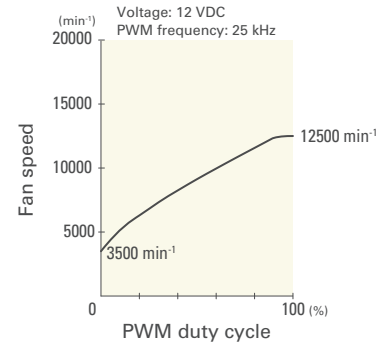

9GA0424P3J001 With pulse sensor with PWM control

PWM duty cycle

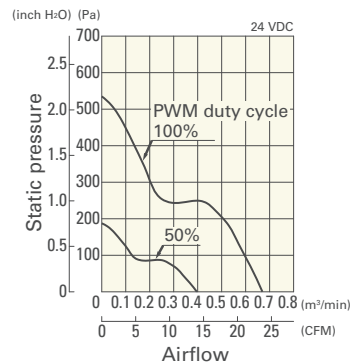

Operating voltage range

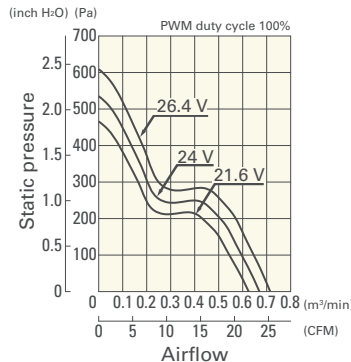

PWM duty - Speed characteristics example

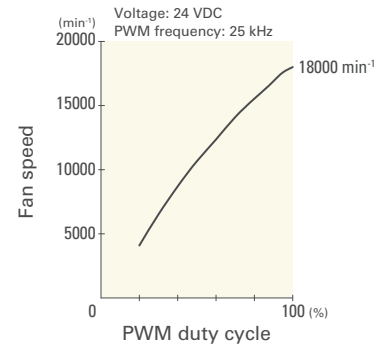

Airflow - Static Pressure Characteristics / PWM Duty - Speed Characteristics Example

9GA0424P3G001 With pulse sensor with PWM control

PWM duty cycle

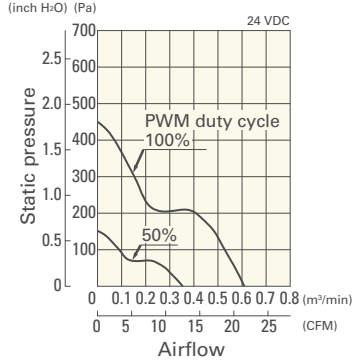

Operating voltage range

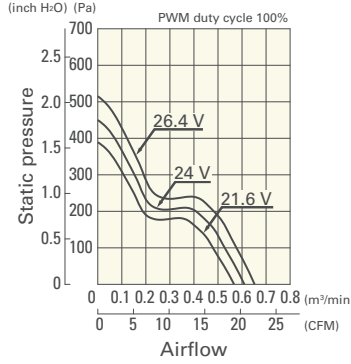

PWM duty - Speed characteristics example

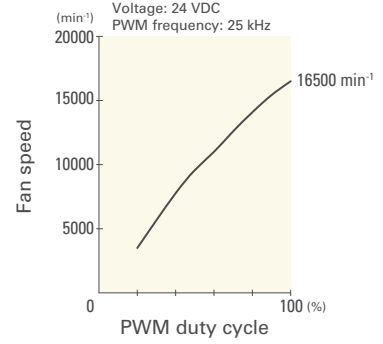

9GA0424P3H001 With pulse sensor with PWM control

PWM duty cycle

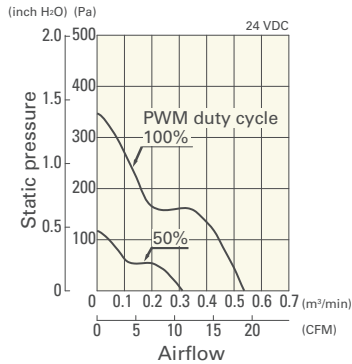

Operating voltage range

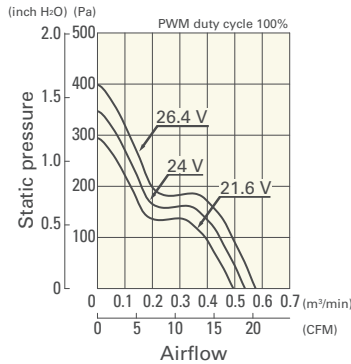

PWM duty - Speed characteristics example

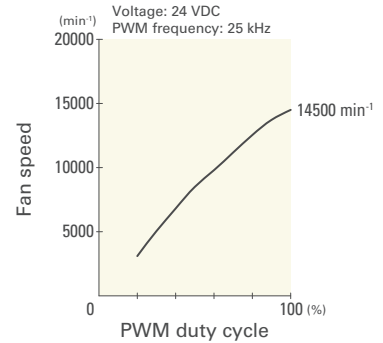

9GA0424P3M001 With pulse sensor with PWM control

PWM duty cycle

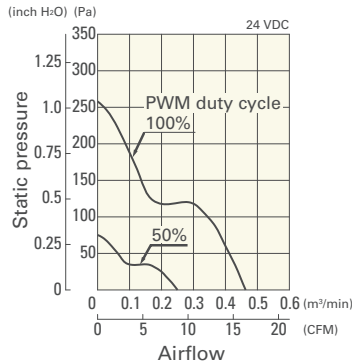

Operating voltage range

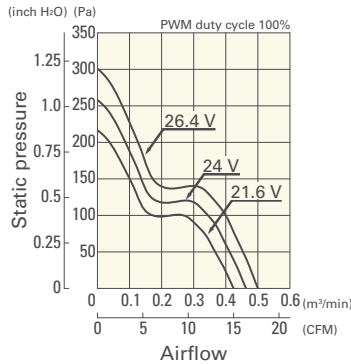

PWM duty - Speed characteristics example

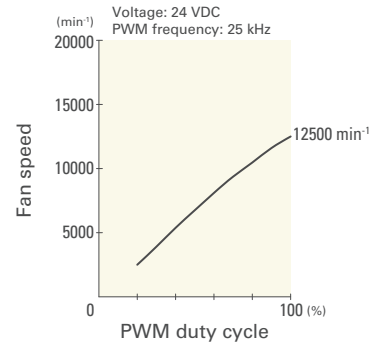

Airflow - Static Pressure Characteristics

9GA0412A301 With pulse sensor

Operating voltage range

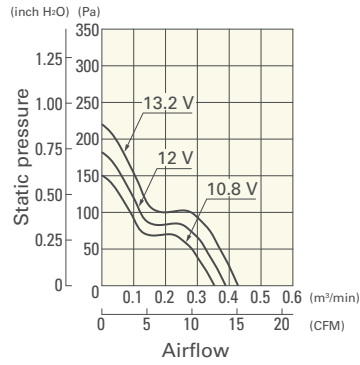

Dimensions (unit: mm) (Ribbed frame with pulse sensor with PWM control)

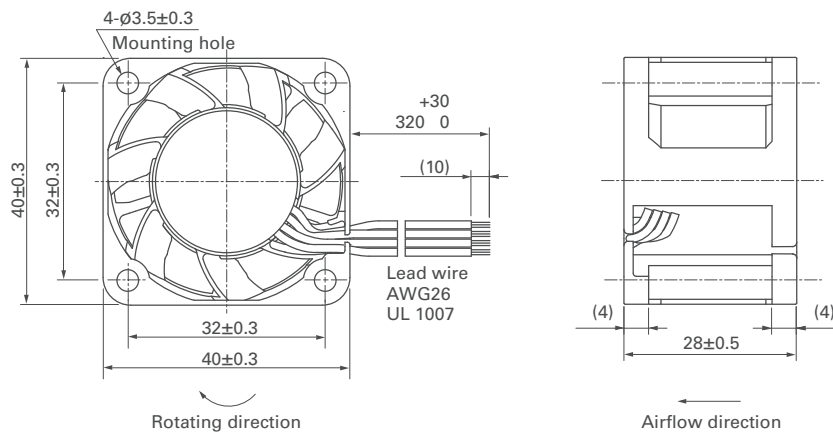

Reference Dimensions of Mounting Holes and Vent Opening (unit: mm)

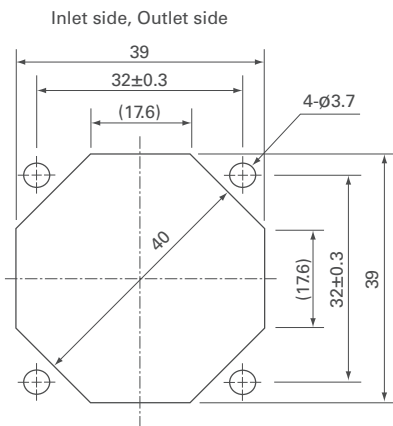

Options

Finger guards

page: p. 598

Model no.: 109-059, 109-059H