



40x40x20 mm

San Ace 40 9GA type Low Power Consumption Fan

General Specifications

- Material Frame: Plastic (Flammability: UL 94V-0), Impeller: Plastic (Flammability: UL 94V-0)
- Expected life See the table below. (L10 life: 90% survival rate for continuous operation in free air at 60°C, rated voltage)
Expected life at 40°C is for reference only.
- Motor protection function Locked rotor burnout protection, Reverse polarity protection
For details, please refer to p. 614.
- Dielectric strength 50/60 Hz, 500 VAC, for 1 minute (between lead wire conductors and frame)
- Insulation resistance 10 MΩ min. at 500 VDC (between lead wire conductors and frame)
- Sound pressure level (SPL) A-weighted sound pressure level (SPL) at 1 m away from the air inlet.
- Storage temperature -30 to +70°C (Non-condensing)
- Lead wire ⊕Red ⊖Black Sensor Yellow Control Brown
- Mass 35 g

Specifications

The models listed below **have ribs and a pulse sensor with PWM control.**

Model no.	Rated voltage [V]	Operating voltage range [V]	PWM duty cycle* [%]	Rated current [A]	Rated input [W]	Rated speed [min ⁻¹]	Max. airflow [m ³ /min] [CFM]	Max. static pressure [Pa] [inchH ₂ O]	SPL [dB (A)]	Operating temperature [°C]	Expected life [h]	
9GA0405P6H001	5	4.5 to 5.5	100	0.35	1.75	12400	0.33 11.7	191 0.77	40	-20 to +70	60000/60°C (90000/40°C)	
9GA0405P6F001			100	0.18	0.9	8000	0.21 7.4	79.5 0.32	28		40000/60°C (70000/40°C)	
9GA0412P6G001	12	10.2 to 13.8	100	0.23	2.76	16000	0.42 14.8	318 1.28	47		40000/60°C (70000/40°C)	
			0	0.04	0.48	3800	0.1 3.5	17.9 0.07	14			
9GA0412P6H001			100	0.14	1.68	12400	0.33 11.7	191 0.77	40		60000/60°C (90000/40°C)	
			0	0.04	0.48	3800	0.1 3.5	17.9 0.07	14			
9GA0412P6F001	12	10.2 to 13.8	100	0.08	0.96	8000	0.21 7.4	79.5 0.32	28			60000/60°C (90000/40°C)
			0	0.03	0.36	2200	0.06 2.1	6.0 0.02	10			
9GA0424P6G001	24	20.4 to 27.6	100	0.13	3.12	16000	0.42 14.8	318 1.28	47			40000/60°C (70000/40°C)
9GA0424P6H001			100	0.08	1.92	12400	0.33 11.7	191 0.77	40		60000/60°C (90000/40°C)	
9GA0424P6F001			100	0.04	0.96	8000	0.21 7.4	79.5 0.32	28			

* PWM frequency is 25 kHz. Models without ratings for 0% PWM duty cycle have zero speed at 0%. When control terminal is open, speed is the same as at 100% duty cycle.

Note 1: Sensor and control options are available for selection. Refer to the table on p. 642.

Note 2: The mark indicates Short Lead Time Service applicable models. See p. 668 for details.

Airflow - Static Pressure Characteristics / PWM Duty - Speed Characteristics Example

9GA0405P6H001 With pulse sensor with PWM control

PWM duty cycle

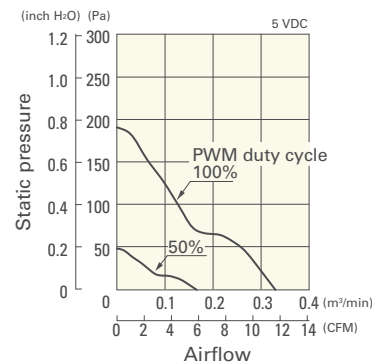

Operating voltage range

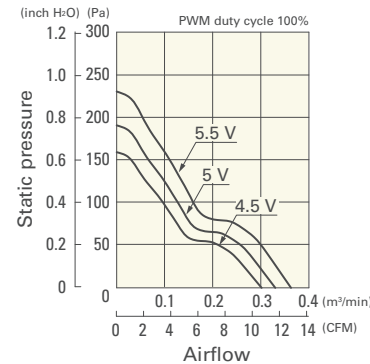

PWM duty - Speed characteristics example

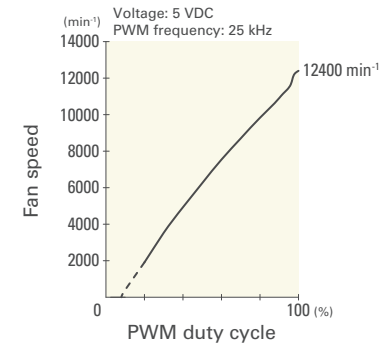

Airflow - Static Pressure Characteristics / PWM Duty - Speed Characteristics Example

9GA0405P6F001 With pulse sensor with PWM control

PWM duty cycle

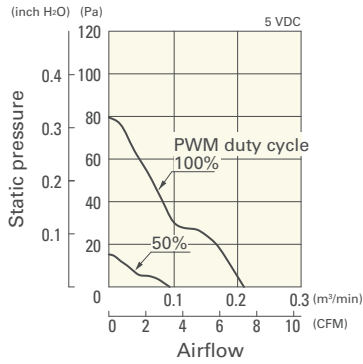

Operating voltage range

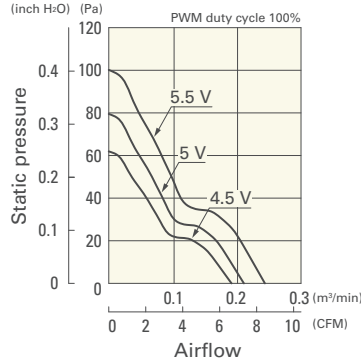

PWM duty - Speed characteristics example

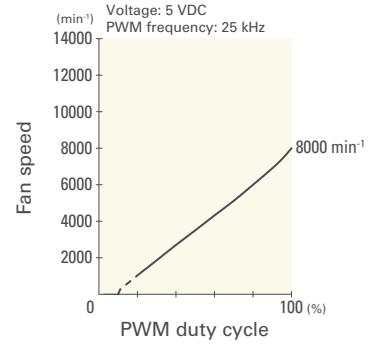

9GA0412P6G001 With pulse sensor with PWM control

PWM duty cycle

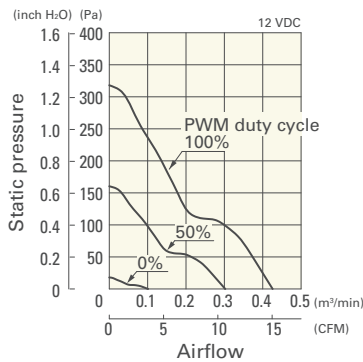

Operating voltage range

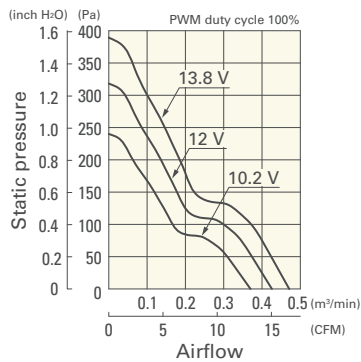

PWM duty - Speed characteristics example

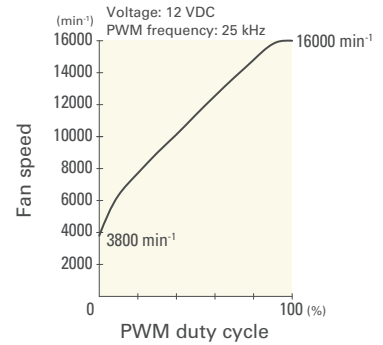

9GA0412P6H001 With pulse sensor with PWM control

PWM duty cycle

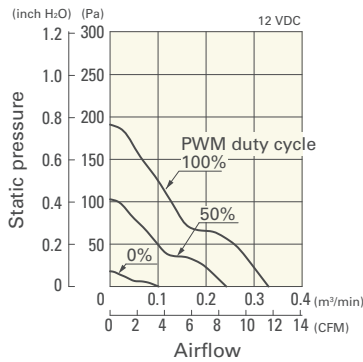

Operating voltage range

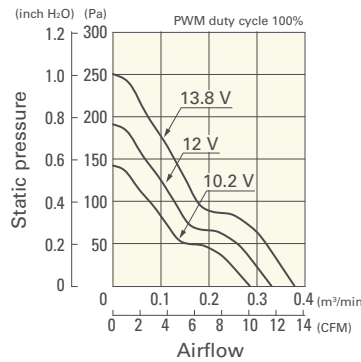

PWM duty - Speed characteristics example

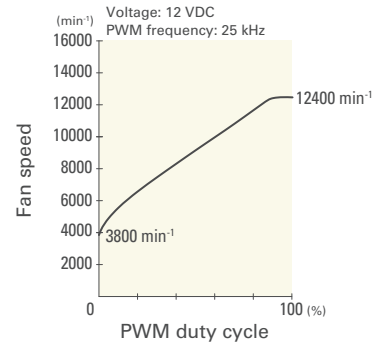

9GA0412P6F001 With pulse sensor with PWM control

PWM duty cycle

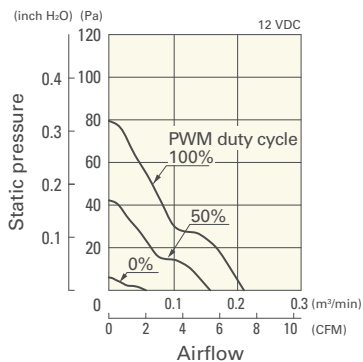

Operating voltage range

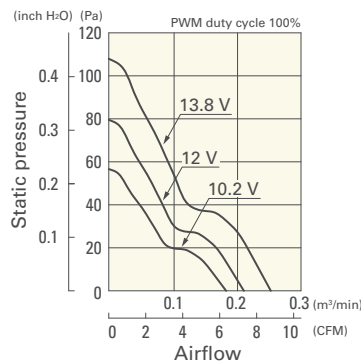

PWM duty - Speed characteristics example

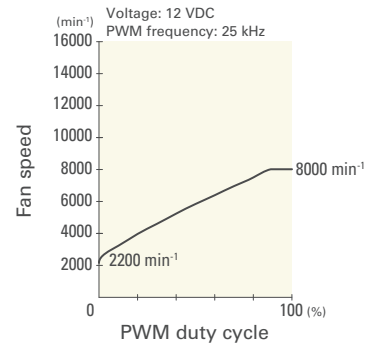

Airflow - Static Pressure Characteristics / PWM Duty - Speed Characteristics Example

DC Fan 40 mm sq.

9GA0424P6G001 With pulse sensor with PWM control

PWM duty cycle

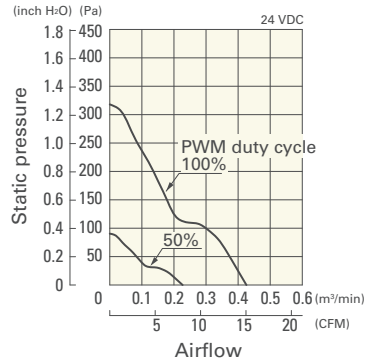

Operating voltage range

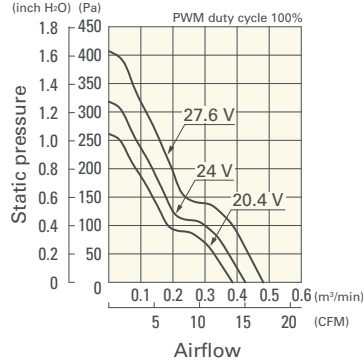

PWM duty - Speed characteristics example

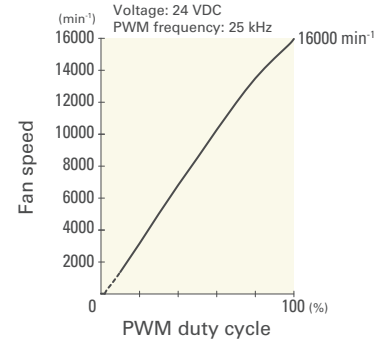

9GA0424P6H001 With pulse sensor with PWM control

PWM duty cycle

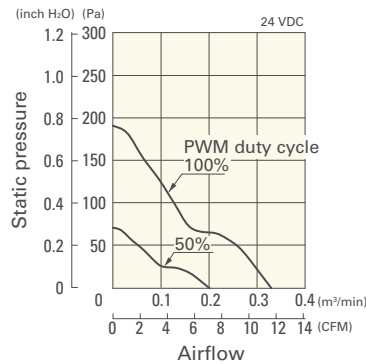

Operating voltage range

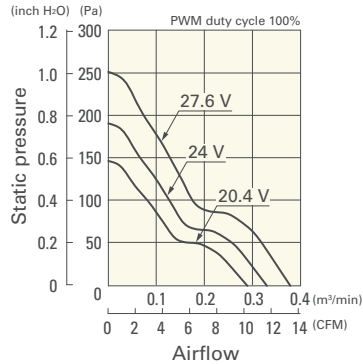

PWM duty - Speed characteristics example

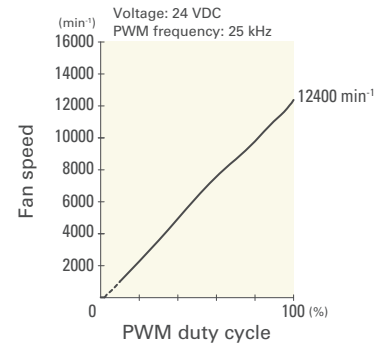

9GA0424P6F001 With pulse sensor with PWM control

PWM duty cycle

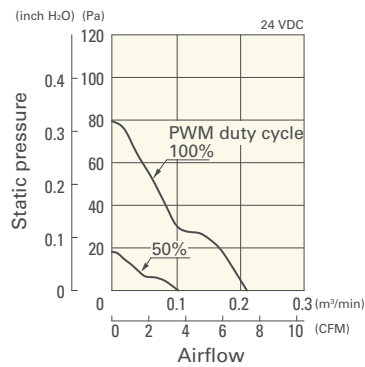

Operating voltage range

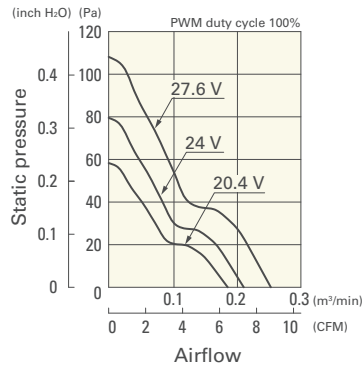

PWM duty - Speed characteristics example

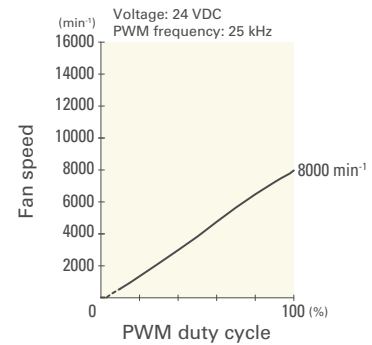

Dimensions (unit: mm)

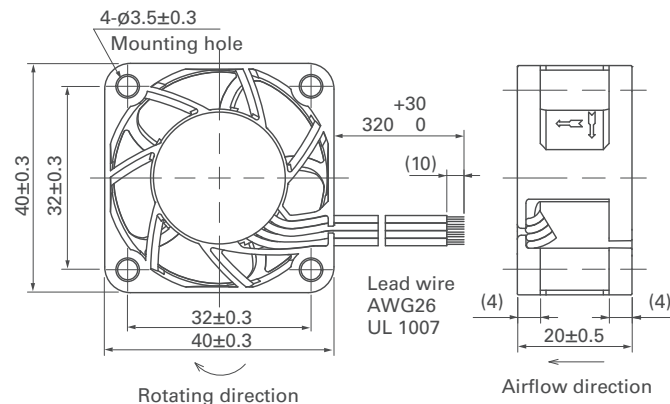

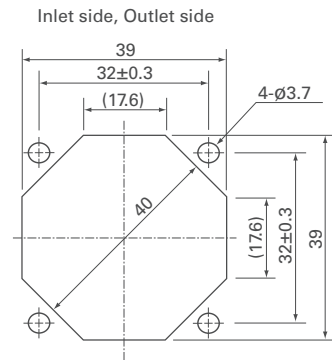
Reference Dimensions of Mounting Holes and Vent Opening (unit: mm)**Options**

Finger guards

page: p. 598

Model no.: 109-059, 109-059H