

80x80x25 mm



San Ace 80 9GA type Low Power Consumption Fan

General Specifications

- Material Frame: Plastic (Flammability: UL 94V-0), Impeller: Plastic (Flammability: UL 94V-0)
- Expected life See the table below. (L10 life: 90% survival rate for continuous operation in free air at 60°C, rated voltage) Expected life at 40°C is for reference only.
- Motor protection function Locked rotor burnout protection, Reverse polarity protection
For details, please refer to p. 614.
- Dielectric strength 50/60 Hz, 500 VAC, for 1 minute (between lead wire conductors and frame)
- Insulation resistance 10 MΩ min. at 500 VDC (between lead wire conductors and frame)
- Sound pressure level (SPL) A-weighted sound pressure level (SPL) at 1 m away from the air inlet.
- Storage temperature -30 to +70°C (Non-condensing)
- Lead wire ⊕Red ⊖Black Sensor Yellow Control Brown
- Mass 110 g

Specifications

The models listed below **have ribs and a pulse sensor with PWM control**. For models without ribs, append "1" to the end of model numbers.

Model no.	Rated voltage [V]	Operating voltage range [V]	PWM duty cycle* [%]	Rated current [A]	Rated input [W]	Rated speed [min ⁻¹]	Max. airflow [m ³ /min] [CFM]	Max. static pressure [Pa] [inchH ₂ O]	SPL [dB (A)]	Operating temperature [°C]	Expected life [h]
9GA0812P4J001	12	10.8 to 13.2	100	0.6	7.2	7400	2.07 73.0	177.6 0.7	48	-20 to +70	60000/60°C (90000/40°C)
			25	0.08	0.96	2500	0.69 24.3	20.2 0.08	21		
9GA0812P4G001			100	0.48	5.76	6800	1.91 67.4	150 0.6	45		
			25	0.06	0.72	1500	0.42 14.8	7.2 0.02	17		
9GA0812P4H001			100	0.22	2.64	5200	1.46 51.5	87.7 0.35	37		
			25	0.06	0.72	1600	0.44 15.5	8.3 0.03	17		
9GA0824P4J001	24	21.6 to 26.4	100	0.28	6.72	7400	2.07 73.0	177.6 0.7	48		
			25	0.06	1.44	2800	0.78 27.5	25.4 0.1	23		
9GA0824P4G001			100	0.21	5.04	6800	1.91 67.4	150 0.6	45		
			25	0.04	0.96	2100	0.58 20.4	14.3 0.05	19		
9GA0824P4H001			100	0.1	2.4	5200	1.46 51.5	87.7 0.35	37		
			25	0.02	0.48	1500	0.42 14.8	7.2 0.02	17		

* PWM frequency is 25 kHz. Models without ratings for 0% PWM duty cycle have zero speed at 0%. When control terminal is open, speed is the same as at 100% duty cycle.

Note 1: Sensor and control options are available for selection. Refer to the table on p. 644.

Note 2: The mark indicates Short LeadTime Service applicable models. See p. 668 for details.

Airflow - Static Pressure Characteristics / PWM Duty - Speed Characteristics Example

9GA0812P4J001 With pulse sensor with PWM control

PWM duty cycle

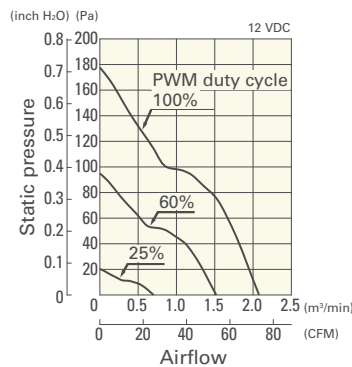

Operating voltage range

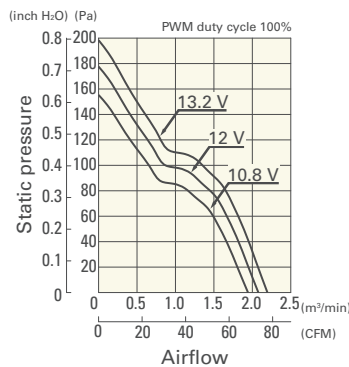

PWM duty - Speed characteristics example

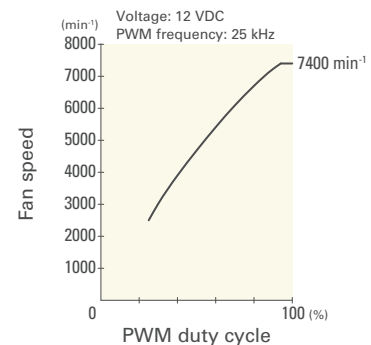

9GA0812P4G001 With pulse sensor with PWM control

PWM duty cycle

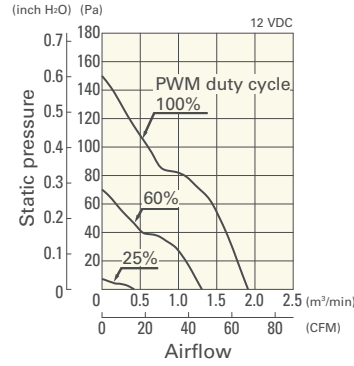

Operating voltage range

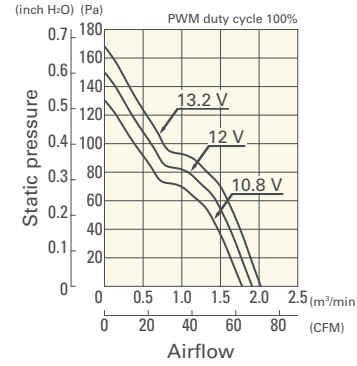

PWM duty - Speed characteristics example

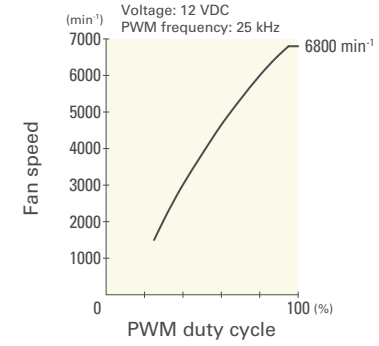

9GA0812P4H001 With pulse sensor with PWM control

PWM duty cycle

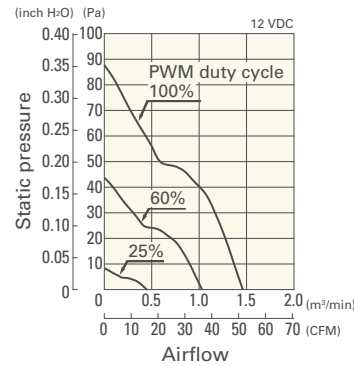

Operating voltage range

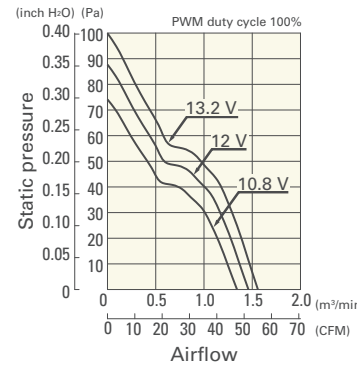

PWM duty - Speed characteristics example

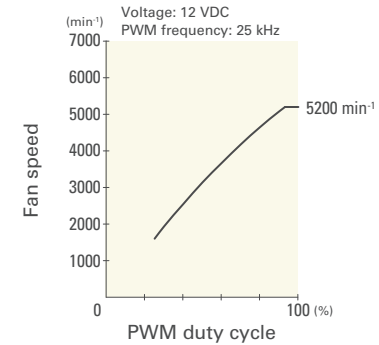

9GA0824P4J001 With pulse sensor with PWM control

PWM duty cycle

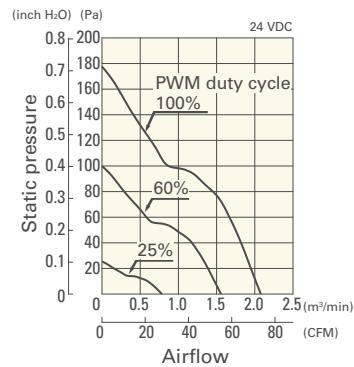

Operating voltage range

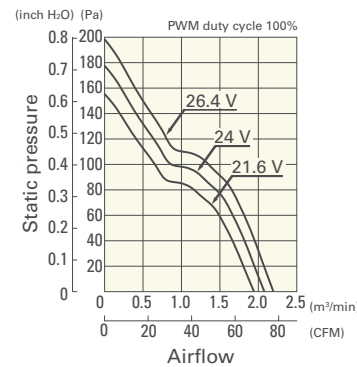

PWM duty - Speed characteristics example

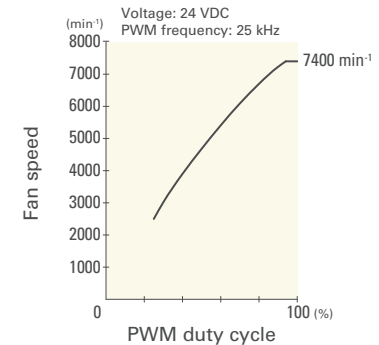

9GA0824P4G001 With pulse sensor with PWM control

PWM duty cycle

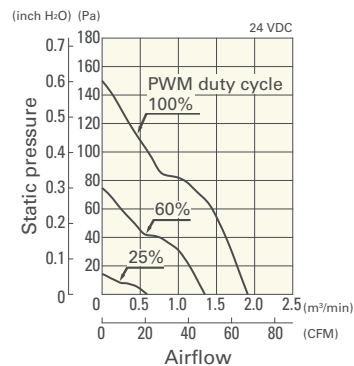

Operating voltage range

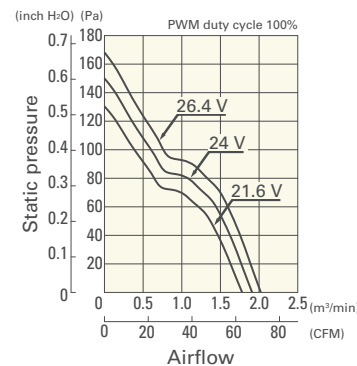

PWM duty - Speed characteristics example

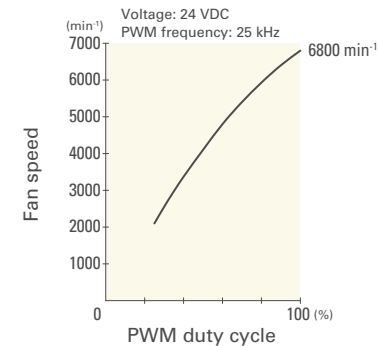

Airflow - Static Pressure Characteristics / PWM Duty - Speed Characteristics Example

9GA0824P4H001 With pulse sensor with PWM control

PWM duty cycle

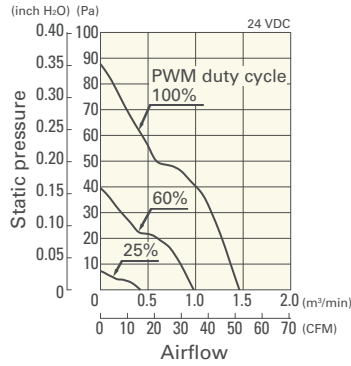

Operating voltage range

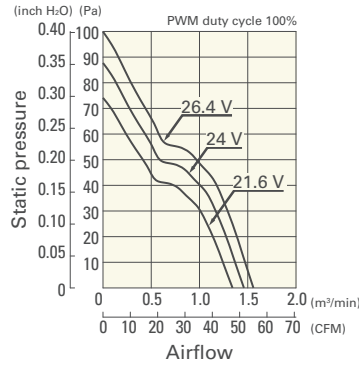

PWM duty - Speed characteristics example

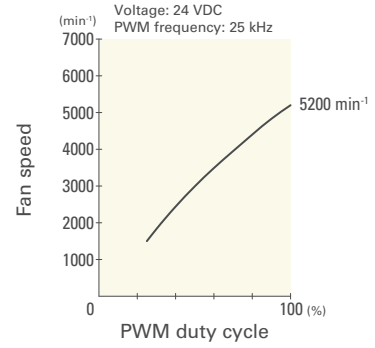

Dimensions (unit: mm) (With ribs)

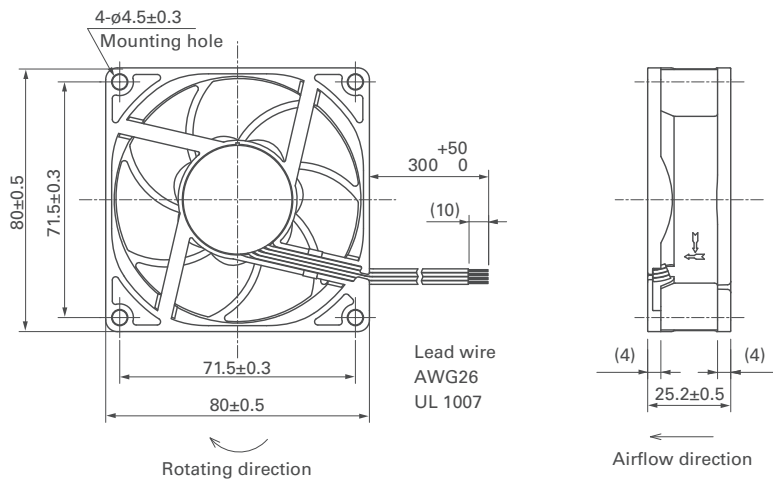

Reference Dimensions of Mounting Holes and Vent Opening (unit: mm)

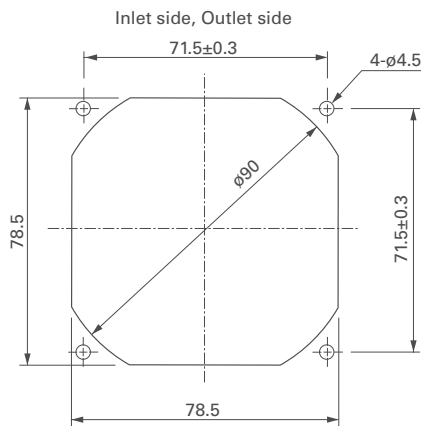

Options

Finger guards page: p. 598

Model no.: 109-049E, 109-049H

Resin finger guards page: p. 605

Model no.: 109-1002G

Resin filter kits page: p. 606

Model no.: 109-1002F13 (13PPI), 109-1002F20 (20PPI),
109-1002F30 (30PPI), 109-1002F40 (40PPI)