

120×120×38 mm

San Ace 120L 9GL type   



General Specifications

- Material Frame: Aluminum, Impeller: Plastic (Flammability: UL 94V-1)
- Expected life See the table below. (L10 life: 90% survival rate for continuous operation in free air at 60°C, rated voltage)
Expected life at 40°C is for reference only.
- Motor protection function Locked rotor burnout protection, Reverse polarity protection
For details, please refer to p. 614.
- Dielectric strength 50/60 Hz, 500 VAC, for 1 minute (between lead wire conductors and frame)
- Insulation resistance 10 MΩ min. at 500 VDC (between lead wire conductors and frame)
- Sound pressure level (SPL) A-weighted sound pressure level (SPL) at 1 m away from the air inlet.
- Storage temperature -30 to +70°C (Non-condensing)
- Lead wire ⊕Red ⊖Black or Blue Sensor Yellow
- Mass 370 g

Specifications

The models listed below **have a pulse sensor**.

Model no.	Rated voltage [V]	Operating voltage range [V]	Rated current [A]	Rated input [W]	Rated speed [min ⁻¹]	Max. airflow [m ³ /min] [CFM]	Max. static pressure [Pa] [inchH ₂ O]	SPL [dB (A)]	Operating temperature [°C]	Expected life [h]
9GL1212G101	12	10.2 to 13.8	0.98	11.8	3600	3.88 137	135 0.542	49	-20 to +70	80000/60°C (115000/40°C)
9GL1212E101			0.61	7.32	3100	3.34 118	100 0.402	46		
9GL1212H101			0.38	4.56	2600	2.8 99	70.4 0.283	39		
9GL1212F101		7 to 13.8	0.28	3.36	2280	2.45 87	54.2 0.218	36		100000/60°C (135000/40°C)
9GL1212M101			0.21	2.52	1950	2.1 74	39.6 0.159	32		
9GL1224G101			24	20.4 to 27.6	0.5	12.0	3600	3.88 137		
9GL1224E101	0.34	8.16			3100	3.34 118	100 0.402	46		
9GL1224H101	0.22	5.28			2600	2.8 99	70.4 0.283	39		
9GL1224F101	14 to 27.6	0.16		3.84	2280	2.45 87	54.2 0.218	36		100000/60°C (135000/40°C)
9GL1224M101		0.11		2.64	1950	2.1 74	39.6 0.159	32		
9GL1248G101		48		40.8 to 55.2	0.25	12.0	3600	3.88 137		
9GL1248E101	0.17		8.16		3100	3.34 118	100 0.402	46		
9GL1248H101	0.11		5.28		2600	2.8 99	70.4 0.283	39	100000/60°C (135000/40°C)	
9GL1248F101	0.09		4.32		2280	2.45 87	54.2 0.218	36		
9GL1248M101	0.07		3.36		1950	2.1 74	39.6 0.159	32		

Note 1: Sensor and control options are available for selection. Refer to the table on p. 645.

Note 2: The  mark indicates Short Lead Time Service applicable models. See p. 668 for details.

Airflow - Static Pressure Characteristics

9GL1212G101 With pulse sensor

Operating voltage range

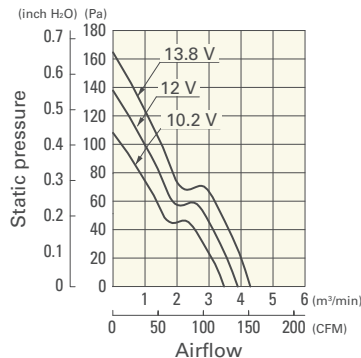

9GL1212E101 With pulse sensor

Operating voltage range

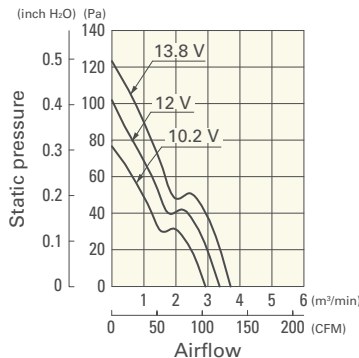

9GL1212H101 With pulse sensor

Operating voltage range

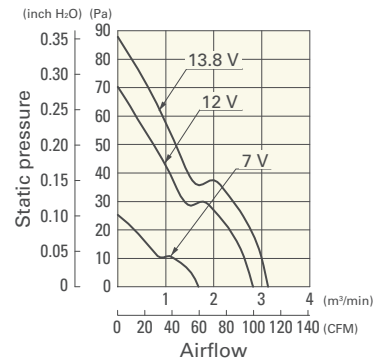

DC

Long Life Fan 120 mm sq.

Airflow - Static Pressure Characteristics

DC
Long Life Fan 120 mm sq.

9GL1212F101 With pulse sensor

Operating voltage range

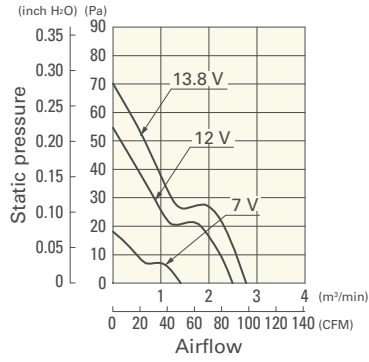

9GL1212M101 With pulse sensor

Operating voltage range

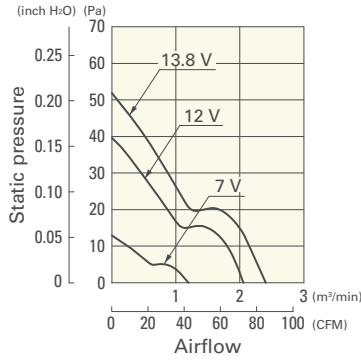

9GL1224G101 With pulse sensor

Operating voltage range

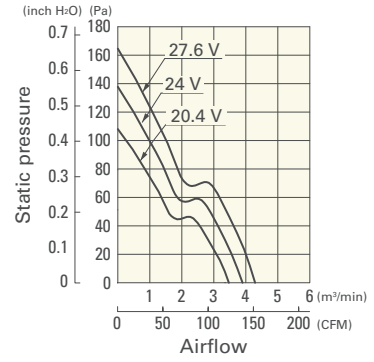

9GL1224E101 With pulse sensor

Operating voltage range

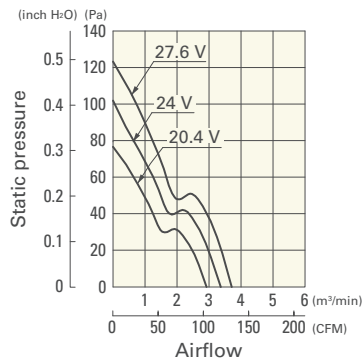

9GL1224H101 With pulse sensor

Operating voltage range

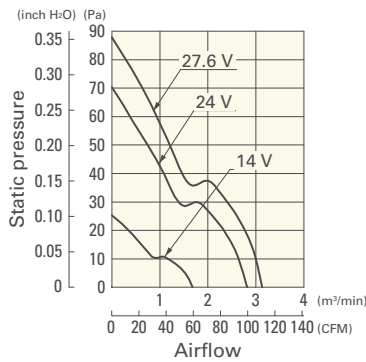

9GL1224F101 With pulse sensor

Operating voltage range

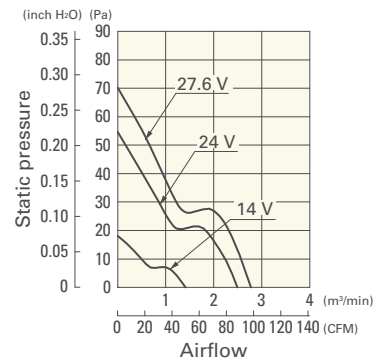

9GL1224M101 With pulse sensor

Operating voltage range

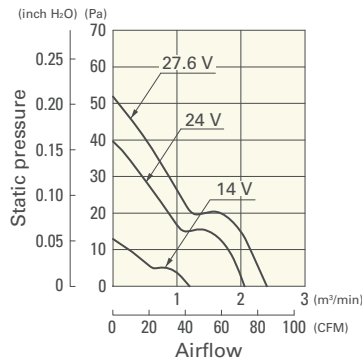

9GL1248G101 With pulse sensor

Operating voltage range

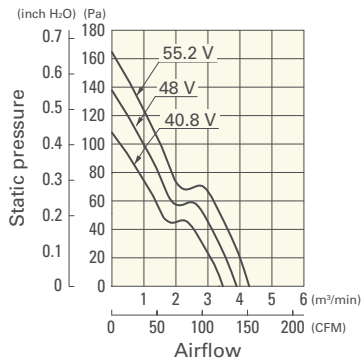

9GL1248E101 With pulse sensor

Operating voltage range

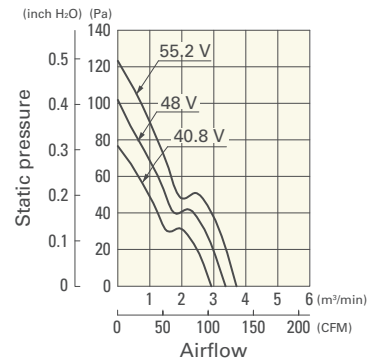

9GL1248H101 With pulse sensor

Operating voltage range

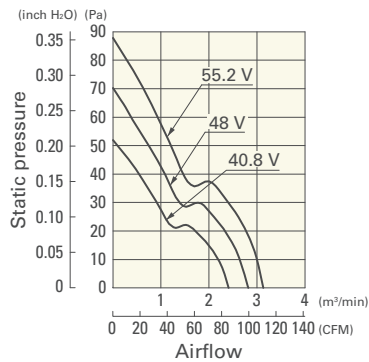

9GL1248F101 With pulse sensor

Operating voltage range

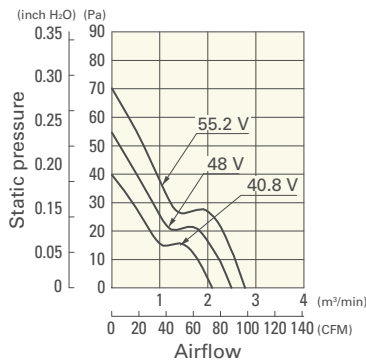

9GL1248M101 With pulse sensor

Operating voltage range

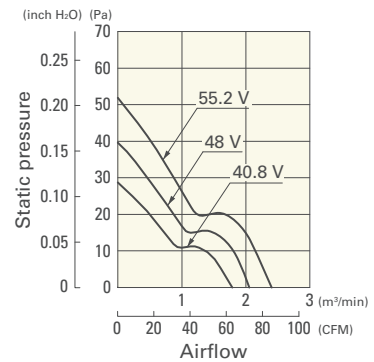

Dimensions (unit: mm)

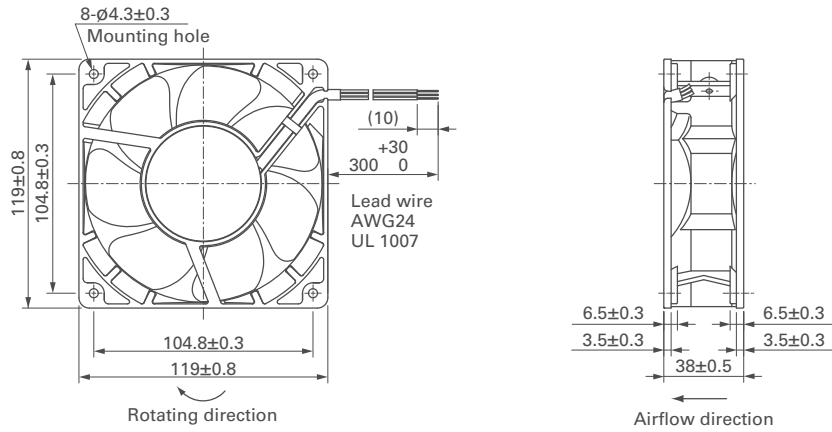

Reference Dimensions of Mounting Holes and Vent Opening (unit: mm)

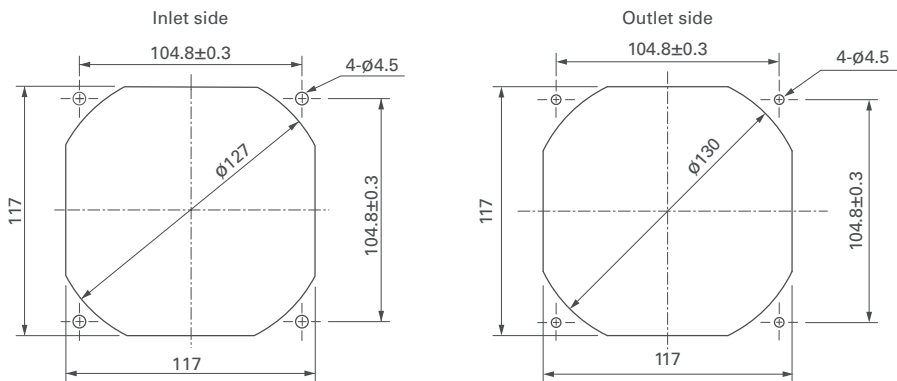

Options

Finger guards

page: p. 599

Model no.: 109-019E, 109-019K

Resin finger guards

page: p. 605

Model no.: 109-1000G

Resin filter kits

page: p. 606

Model no.: 109-1000F13 (13PPI), 109-1000F20 (20PPI),
109-1000F30 (30PPI), 109-1000F40 (40PPI)

DC

Long Life Fan 120 mm sq.