



60×60×25 mm

San Ace 60L 9LG type

General Specifications

- Material Frame: Aluminum, Impeller: Plastic (Flammability: UL 94V-1)
- Expected life See the table below. (L10 life: 90% survival rate for continuous operation in free air at 60°C, rated voltage) Expected life at 40°C is for reference only.
- Motor protection function Locked rotor burnout protection, Reverse polarity protection For details, please refer to p. 614.
- Dielectric strength 50/60 Hz, 500 VAC, for 1 minute (between lead wire conductors and frame)
- Insulation resistance 10 MΩ min. at 500 VDC (between lead wire conductors and frame)
- Sound pressure level (SPL) A-weighted sound pressure level (SPL) at 1 m away from the air inlet.
- Storage temperature -30 to +70°C (Non-condensing)
- Lead wire ⊕Red ⊖Black Sensor Yellow Control Brown
- Mass 100 g

DC

Long Life Fan 60 mm sq.

Specifications

The models listed below **have a pulse sensor with PWM control.**

Model no.	Rated voltage [V]	Operating voltage range [V]	PWM duty cycle* [%]	Rated current [A]	Rated input [W]	Rated speed [min ⁻¹]	Max. airflow [m ³ /min] [CFM]	Max. static pressure [Pa] [inchH ₂ O]	SPL [dB (A)]	Operating temperature [°C]	Expected life [h]	
» 9LG0612P4S001	12	10.8 to 13.2	100	0.67	8.04	11000	1.4 49.4	300 1.204	53	-20 to +70	180000/60°C (215000/40°C)	
			20	0.06	0.72	2900	0.36 12.7	20.8 0.083	20			
» 9LG0612P4J001			100	0.39	4.68	8650	1.1 38.8	182 0.73	47			
			25	0.04	0.48	2100	0.26 9.1	10.7 0.042	17			
» 9LG0612P4H001			100	0.17	2.04	6150	0.78 27.5	97 0.389	35			
			25	0.03	0.36	1350	0.17 6.0	4.7 0.018	14			
» 9LG0612P4M001		100	0.09	1.08	4200	0.53 18.7	45 0.18	24				
		25	0.03	0.36	900	0.11 3.8	2.0 0.008	14				
» 9LG0624P4S001		24	21.6 to 26.4	100	0.34	8.16	11000	1.4 49.4	300 1.204			53
				20	0.03	0.72	2900	0.36 12.7	20.8 0.083			20
» 9LG0624P4J001				100	0.19	4.56	8650	1.1 38.8	182 0.73			47
				20	0.02	0.48	2200	0.28 9.8	12.0 0.048			17
» 9LG0624P4H001	100			0.08	1.92	6150	0.78 27.5	97 0.389	35			
	20			0.02	0.48	1300	0.16 5.6	4.3 0.017	14			
» 9LG0624P4M001	100		0.04	0.96	4200	0.53 18.7	45 0.18	24				
	20		0.01	0.24	800	0.1 3.5	1.6 0.006	14				
» 9LG0648P4S001	48		36 to 72	100	0.18	8.64	11000	1.4 49.4	305 1.224	53		
				20	0.02	0.96	2900	0.36 12.7	20.8 0.083	20		
» 9LG0648P4J001				100	0.1	4.8	8650	1.1 38.8	182 0.73	47		
				20	0.02	0.96	2100	0.26 9.1	10.7 0.042	17		
» 9LG0648P4H001		100		0.06	2.88	6150	0.78 27.5	97 0.389	35			
		20		0.02	0.96	1000	0.12 4.2	2.5 0.01	14			
» 9LG0648P4M001		100	0.04	1.92	4200	0.53 18.7	45 0.18	24				
		20	0.02	0.96	650	0.08 2.8	1.0 0.004	14				

* PWM frequency is 25 kHz. Models without ratings for 0% PWM duty cycle have zero speed at 0%. When control terminal is open, speed is the same as at 100% duty cycle.

Note 1: Sensor and control options are available for selection. Refer to the table on pp. 647 to 648.

Note 2: The » mark indicates Short Lead Time Service applicable models. See p. 668 for details.

Airflow - Static Pressure Characteristics / PWM Duty - Speed Characteristics Example

9LG0612P4S001 With pulse sensor with PWM control

PWM duty cycle

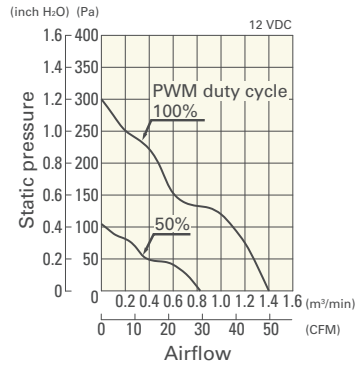

Operating voltage range

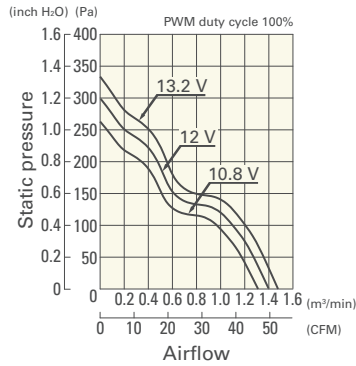

PWM duty - Speed characteristics example

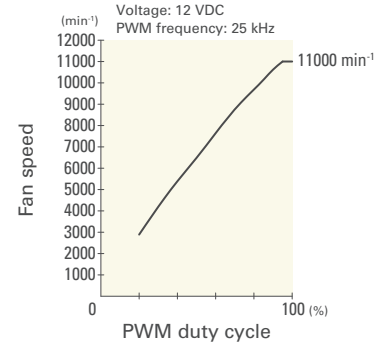

9LG0612P4J001 With pulse sensor with PWM control

PWM duty cycle

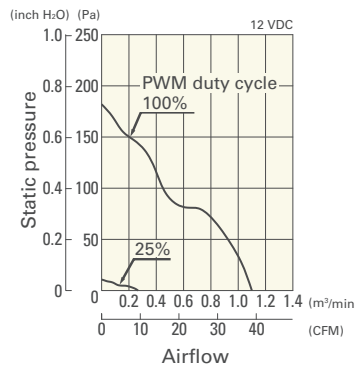

Operating voltage range

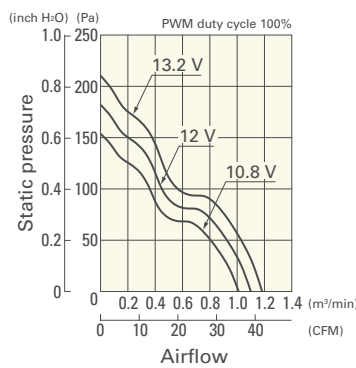

PWM duty - Speed characteristics example

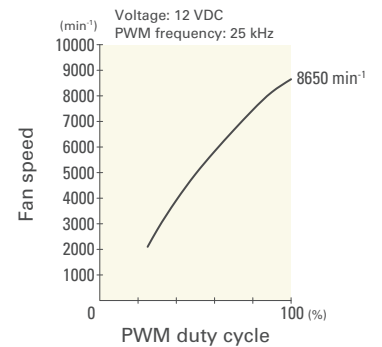

9LG0612P4H001 With pulse sensor with PWM control

PWM duty cycle

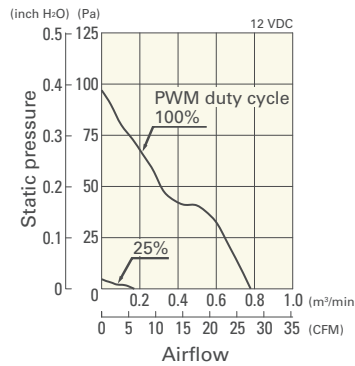

Operating voltage range

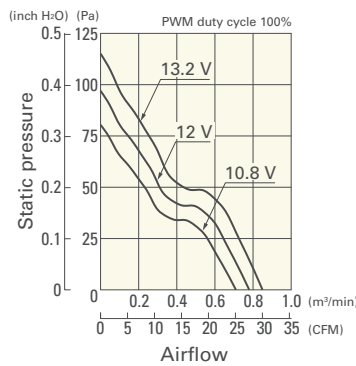

PWM duty - Speed characteristics example

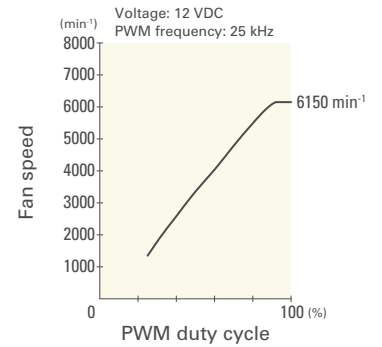

9LG0612P4M001 With pulse sensor with PWM control

PWM duty cycle

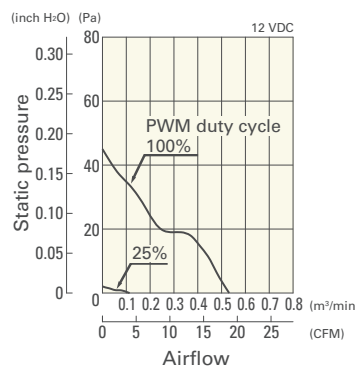

Operating voltage range

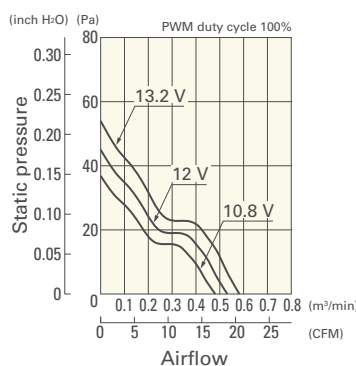

PWM duty - Speed characteristics example

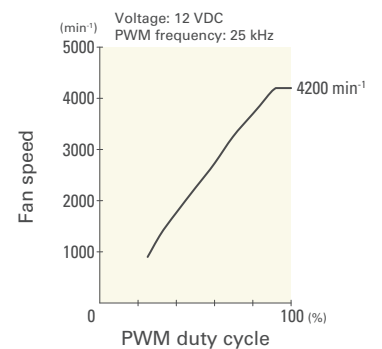

DC

Long Life Fan 60 mm sq.

Airflow - Static Pressure Characteristics / PWM Duty - Speed Characteristics Example

9LG0624P4S001 With pulse sensor with PWM control

PWM duty cycle

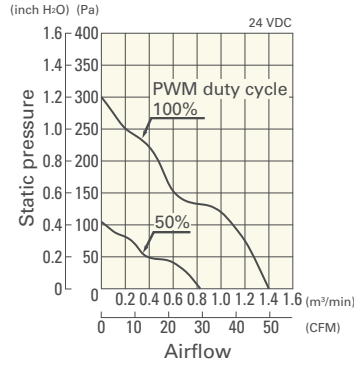

Operating voltage range

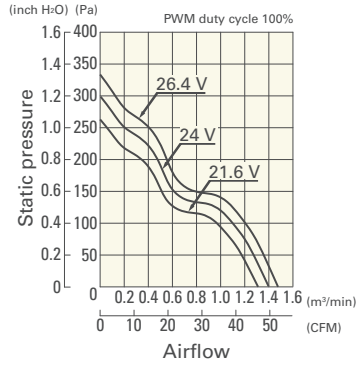

PWM duty - Speed characteristics example

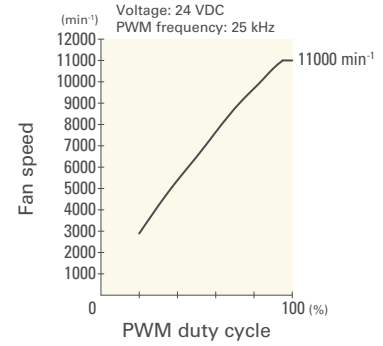

9LG0624P4J001 With pulse sensor with PWM control

PWM duty cycle

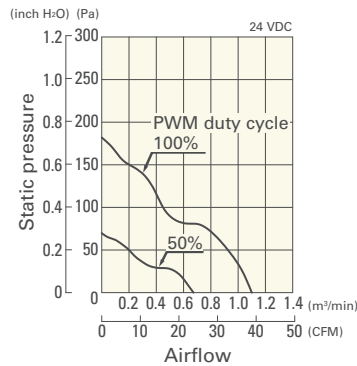

Operating voltage range

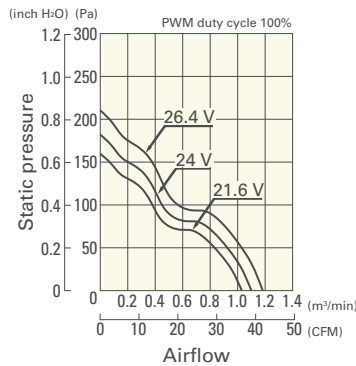

PWM duty - Speed characteristics example

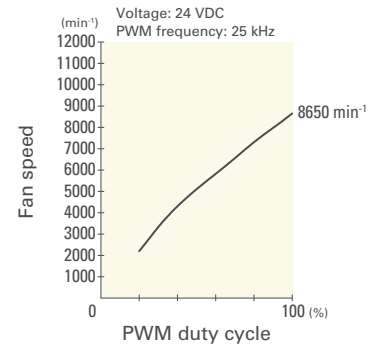

9LG0624P4H001 With pulse sensor with PWM control

PWM duty cycle

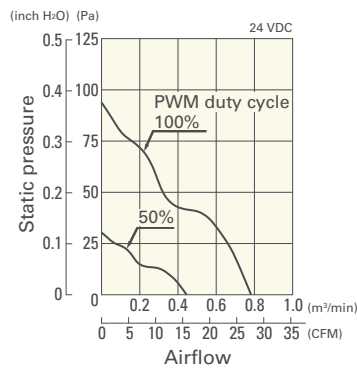

Operating voltage range

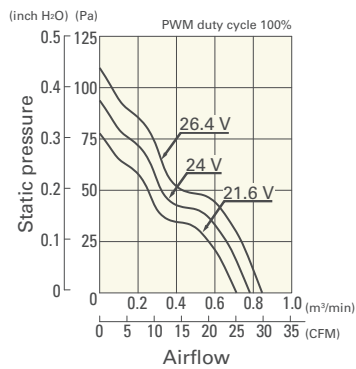

PWM duty - Speed characteristics example

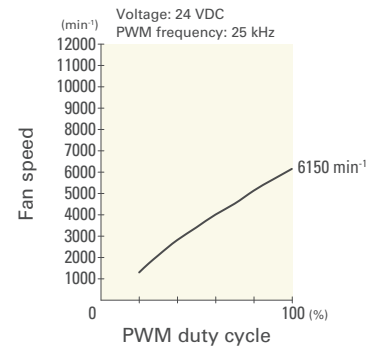

9LG0624P4M001 With pulse sensor with PWM control

PWM duty cycle

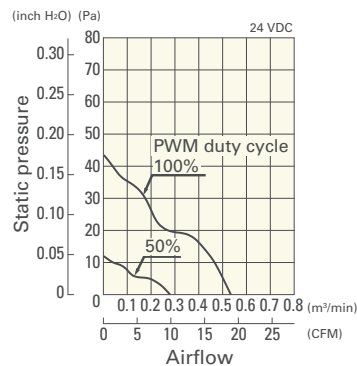

Operating voltage range

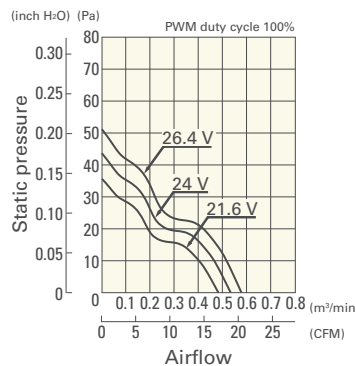

PWM duty - Speed characteristics example

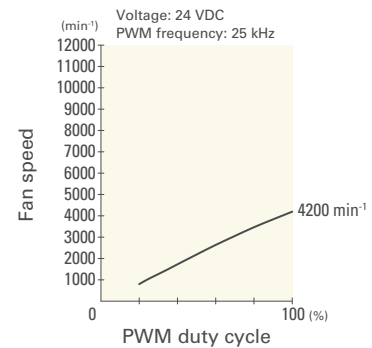

DC
Long Life Fan 60 mm sq.

Airflow - Static Pressure Characteristics / PWM Duty - Speed Characteristics Example

9LG0648P4S001 With pulse sensor with PWM control

PWM duty cycle

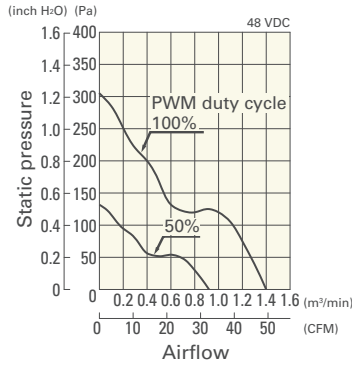

Operating voltage range

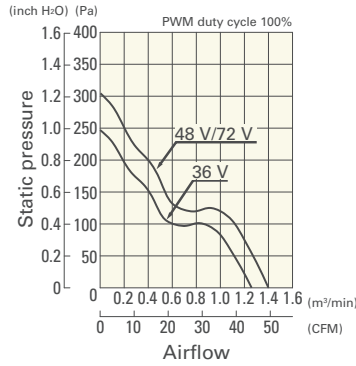

PWM duty - Speed characteristics example

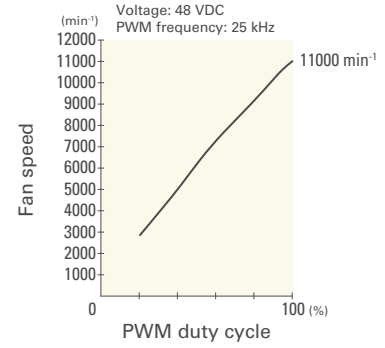

9LG0648P4J001 With pulse sensor with PWM control

PWM duty cycle

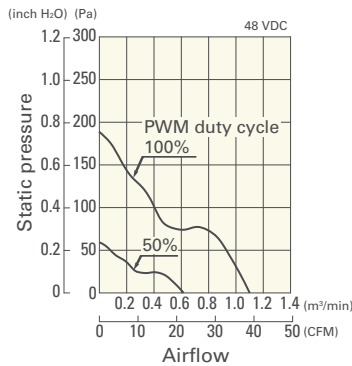

Operating voltage range

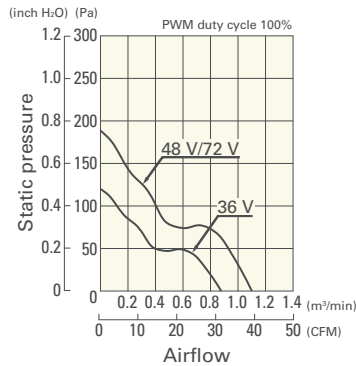

PWM duty - Speed characteristics example

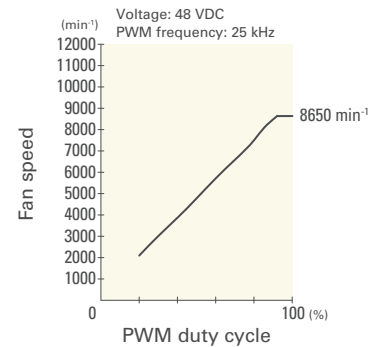

9LG0648P4H001 With pulse sensor with PWM control

PWM duty cycle

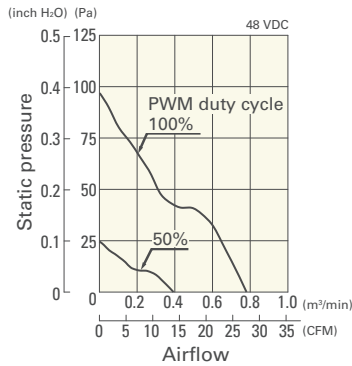

Operating voltage range

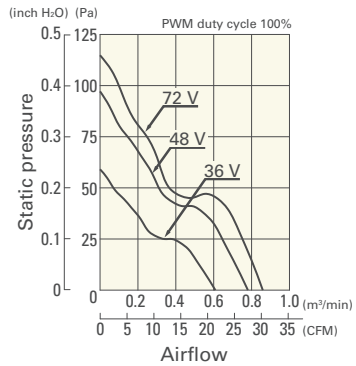

PWM duty - Speed characteristics example

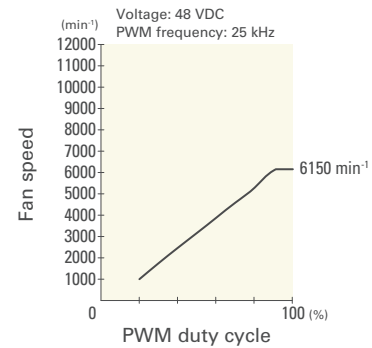

9LG0648P4M001 With pulse sensor with PWM control

PWM duty cycle

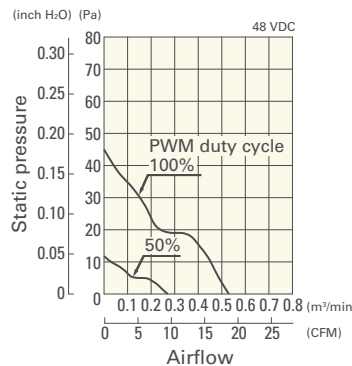

Operating voltage range

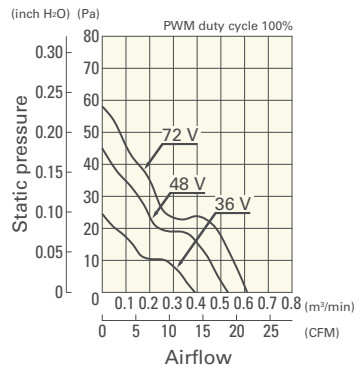

PWM duty - Speed characteristics example

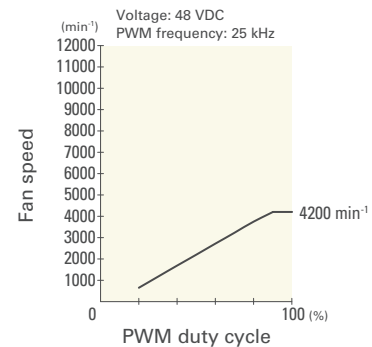

DC

Long Life Fan 60 mm sq.

Dimensions (unit: mm)

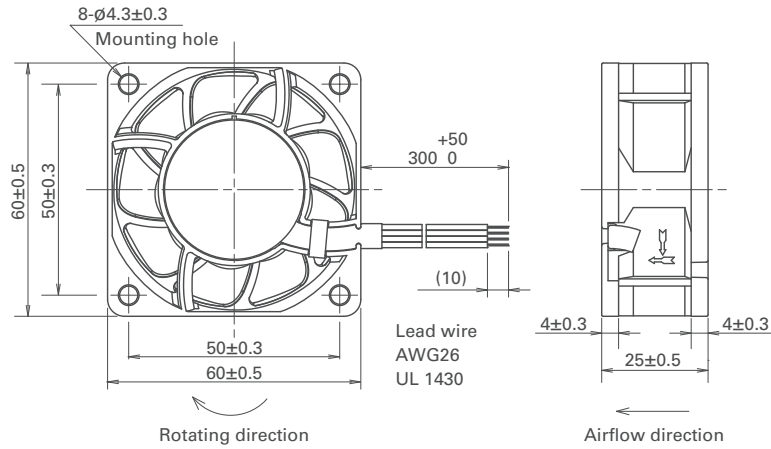

DC
Long Life Fan 60 mm sq.

Reference Dimensions of Mounting Holes and Vent Opening (unit: mm)

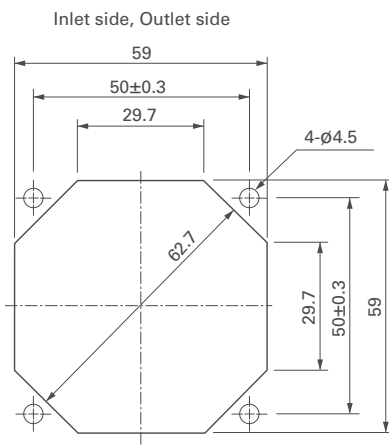

Options

Finger guards

page: p. 598

Model no.: 109-139E, 109-139H

Resin finger guards

page: p. 605

Model no.: 109-1003G

Resin filter kits

page: p. 606

Model no.: 109-1003F13 (13PPI), 109-1003F20 (20PPI),
109-1003F30 (30PPI), 109-1003F40 (40PPI)