



# 120×120×38 mm

San Ace 120W 9WG type   

## General Specifications

- Material ..... Frame: Aluminum (Black coating), Impeller: Plastic (Flammability: UL 94V-1)
- Expected life ..... See the table below. (L10 life: 90% survival rate for continuous operation in indoor free air at 60°C, rated voltage) Expected life at 40°C is for reference only.
- Motor protection function ..... Locked rotor burnout protection, Reverse polarity protection For details, please refer to p. 614.
- Dielectric strength ..... 50/60 Hz, 500 VAC, for 1 minute (between lead wire conductors and frame)
- Insulation resistance ..... 10 MΩ min. at 500 VDC (between lead wire conductors and frame)
- Sound pressure level (SPL) ..... A-weighted sound pressure level (SPL) at 1 m away from the air inlet.
- Storage temperature ..... -30 to +70°C (Non-condensing)
- Lead wire ..... ⊕Red ⊖Black or Blue  Sensor Yellow
- Mass ..... 410 g
- Ingress protection ..... IP55 For more information on IP rating, refer to p. 621.

## Specifications

The models listed below **have a pulse sensor**.

Model no.	Rated voltage [V]	Operating voltage range [V]	Rated current [A]	Rated input [W]	Rated speed [min <sup>-1</sup> ]	Max. airflow [m <sup>3</sup> /min] [CFM]	Max. static pressure [Pa] [inchH <sub>2</sub> O]	SPL [dB (A)]	Operating temperature [°C]	Expected life [h]	
9WG1212G101-E	12	10.2 to 13.8	0.98	11.76	3600	3.88 137	135 0.542	49	-20 to +70	80000/60°C (115000/40°C)	
9WG1212E101-E			0.61	7.32	3100	3.34 118	100 0.402	46			
9WG1212H101-E			0.38	4.56	2600	2.8 99	70.4 0.283	39			
9WG1212F101-E		7 to 13.8	0.28	3.36	2280	2.45 87	54.2 0.218	36			
9WG1212M101-E			0.21	2.52	1950	2.1 74	39.6 0.159	32			
9WG1224G101-E	24	20.4 to 27.6	0.5	12	3600	3.88 137	135 0.542	49		-20 to +70	80000/60°C (115000/40°C)
9WG1224E101-E			0.34	8.16	3100	3.34 118	100 0.402	46			
9WG1224H101-E			0.22	5.28	2600	2.8 99	70.4 0.283	39			
9WG1224F101-E		14 to 27.6	0.16	3.84	2280	2.45 87	54.2 0.218	36			
9WG1224M101-E			0.11	2.64	1950	2.1 74	39.6 0.159	32			
9WG1248G101-E	48	40.8 to 55.2	0.25	12	3600	3.88 137	135 0.542	49		-20 to +70	80000/60°C (115000/40°C)
9WG1248E101-E			0.17	8.16	3100	3.34 118	100 0.402	46			
9WG1248H101-E			0.11	5.28	2600	2.8 99	70.4 0.283	39			
9WG1248F101-E			0.09	4.32	2280	2.45 87	54.2 0.218	36			
9WG1248M101-E			0.07	3.36	1950	2.1 74	39.6 0.159	32			

Note: Sensor and control options are available for selection. Refer to the table on pp. 654 to 655.

## Airflow - Static Pressure Characteristics

9WG1212G101-E With pulse sensor

Operating voltage range

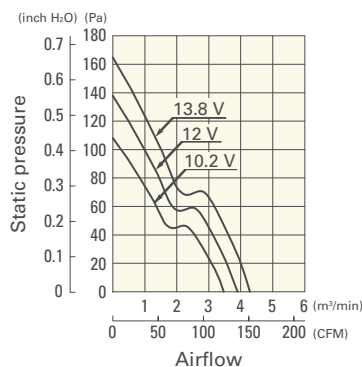

9WG1212E101-E With pulse sensor

Operating voltage range

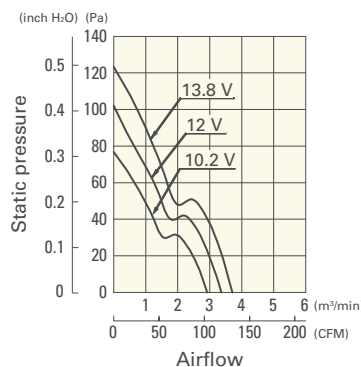

9WG1212H101-E With pulse sensor

Operating voltage range

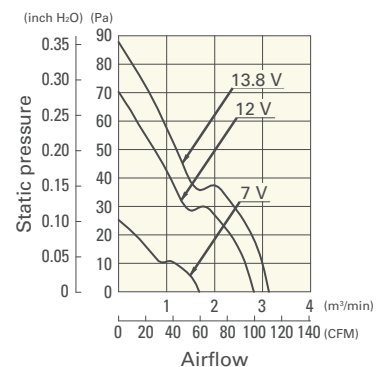

**Airflow - Static Pressure Characteristics**

**9WG1212F101-E** With pulse sensor

Operating voltage range

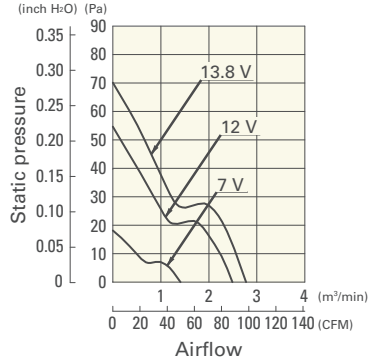

**9WG1212M101-E** With pulse sensor

Operating voltage range

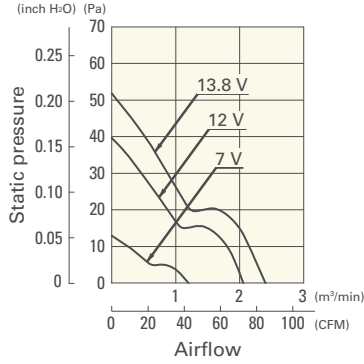

**9WG1224G101-E** With pulse sensor

Operating voltage range

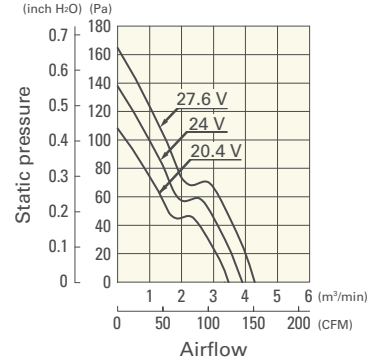

**9WG1224E101-E** With pulse sensor

Operating voltage range

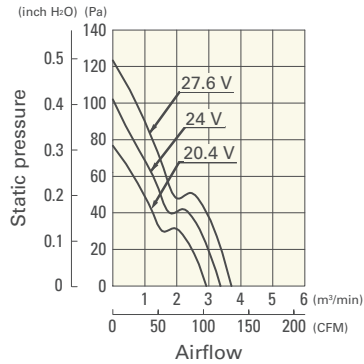

**9WG1224H101-E** With pulse sensor

Operating voltage range

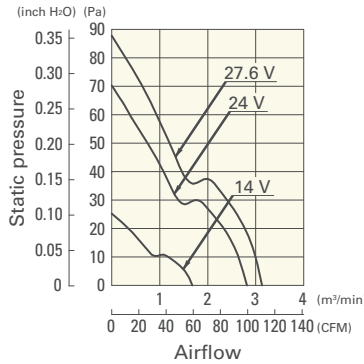

**9WG1224F101-E** With pulse sensor

Operating voltage range

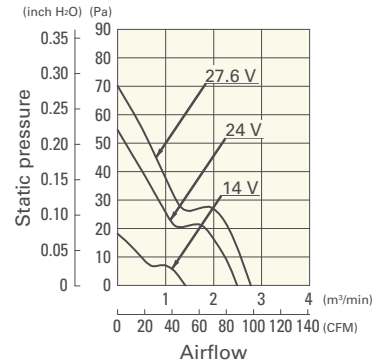

**9WG1224M101-E** With pulse sensor

Operating voltage range

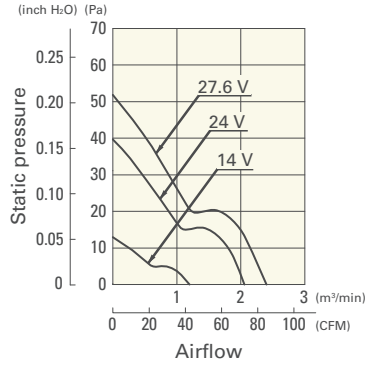

**9WG1248G101-E** With pulse sensor

Operating voltage range

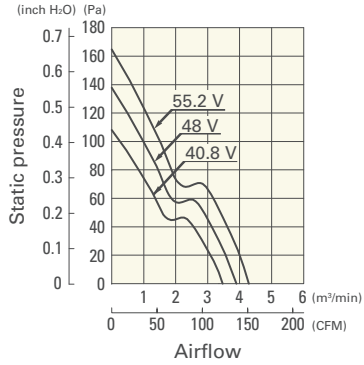

**9WG1248E101-E** With pulse sensor

Operating voltage range

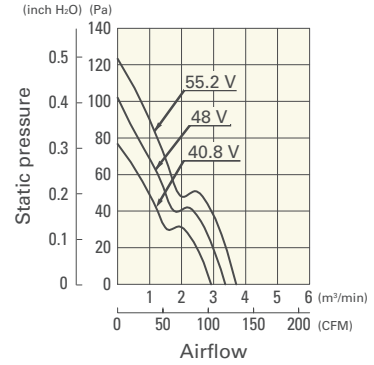

**9WG1248H101-E** With pulse sensor

Operating voltage range

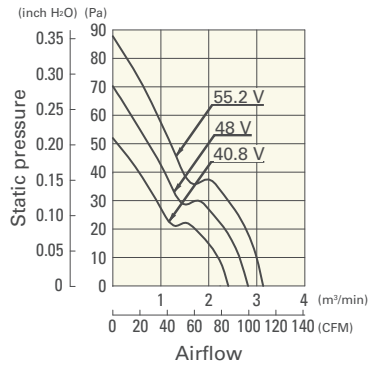

**9WG1248F101-E** With pulse sensor

Operating voltage range

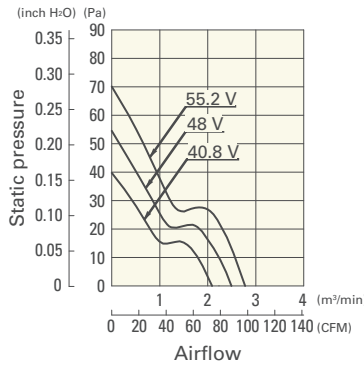

**9WG1248M101-E** With pulse sensor

Operating voltage range

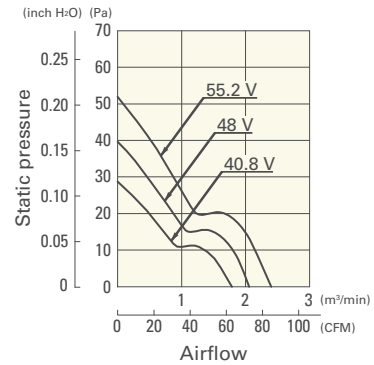

**Dimensions** (unit: mm)

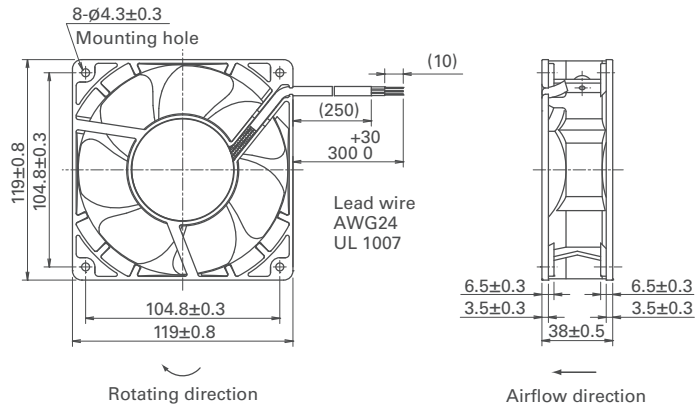

**Reference Dimensions of Mounting Holes and Vent Opening** (unit: mm)

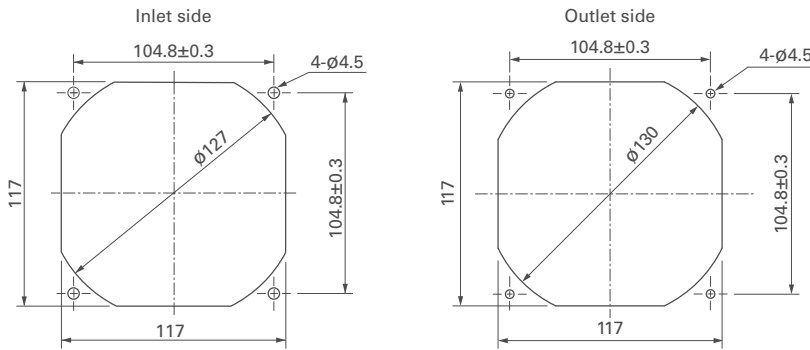

**Options**

Finger guards

page: p. 599

Model no.: 109-019E, 109-019K

Resin finger guards

page: p. 605

Model no.: 109-1000G

DC  
Splash Proof Fan 120 mm sq.