

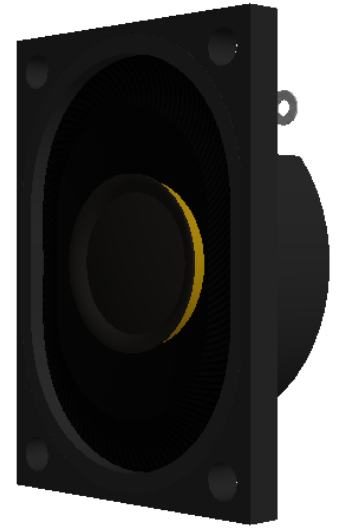

**pui**  
**audio**™ inc  
a projects unlimited company

## AS04008PS-4W-WR-R 40 x 28mm Speaker



3541 Stop Eight Road • Dayton, Ohio 45414

### Product Overview

- 40 x 20mm oval speaker with Neodymium magnet
- 84 dB sensitivity (1W/0.5m)
- 2W continuous, 4W maximum power handling and 8Ω impedance
- Good for music and vocal reproduction; water-resistant cone

Frequency Response (1W @ 0.5 meters)

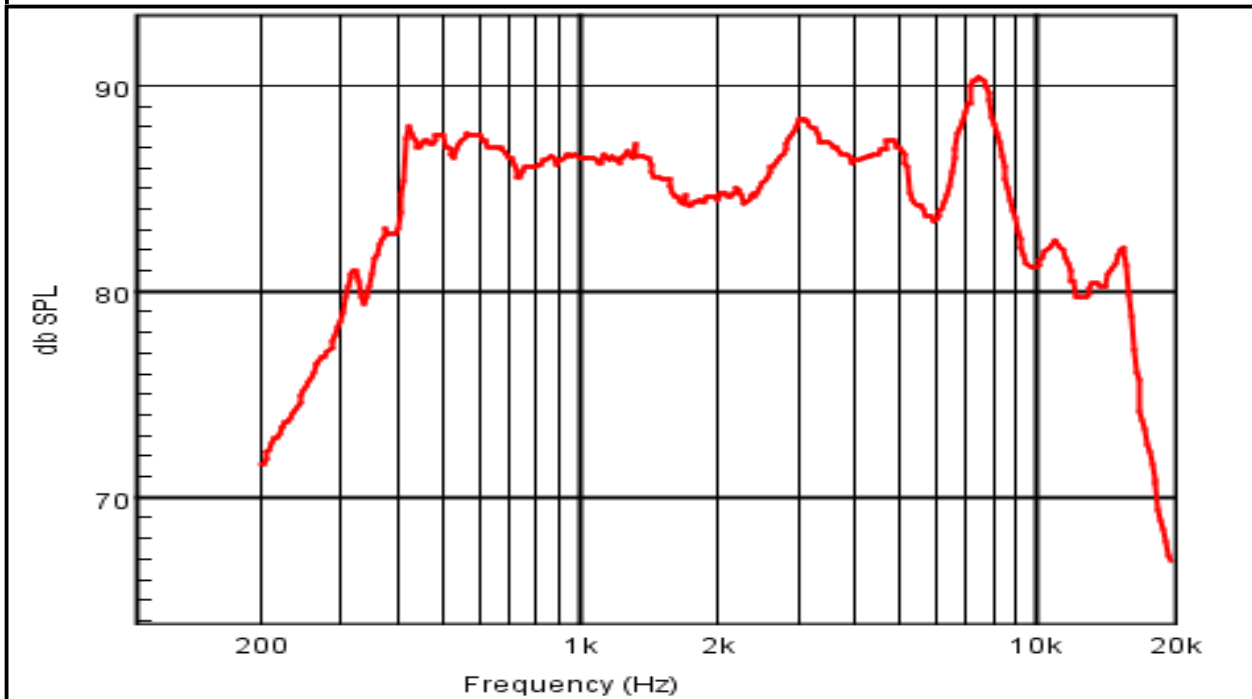

RoHS Compliant



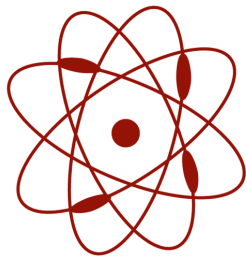

**pui**  
**audio**™ inc  
a projects unlimited company

## AS04008PS-4W-WR-R 40 x 28mm Speaker

### Mechanical and Environment Testing

Test Description	Test Condition
High Temperature	60°C ±2°C with random humidity for 96 hours
Low Temperature	-20°C ±2°C with random humidity for 96 hours
Humidity	40°C with 90% to 95% relative humidity for 96 hours
Vibration	5G constant movement modulated at 10 to 55 Hz for 2 hours each of 3 axis
Drop Test	100 cm free fall onto 20mm thick board, 6 cycles
Temperature Cycle Test	-20°C to 60°C, 4 cycles (refer to Temperature Cycle Test Graph)

After tests, speaker shall rest for 1 hours. SPL shall not deviate ±4 dB from pre-test measurement.

### Temperature Cycle Test Graph

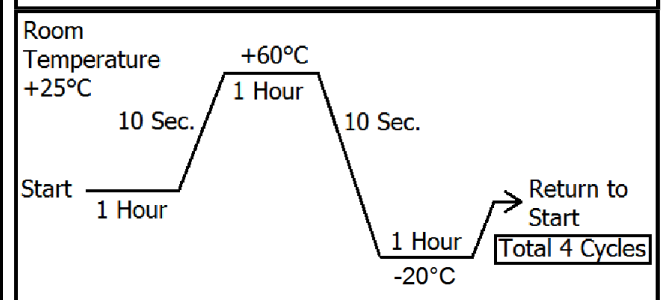

### Frequency Response and SPL Measurement Setup

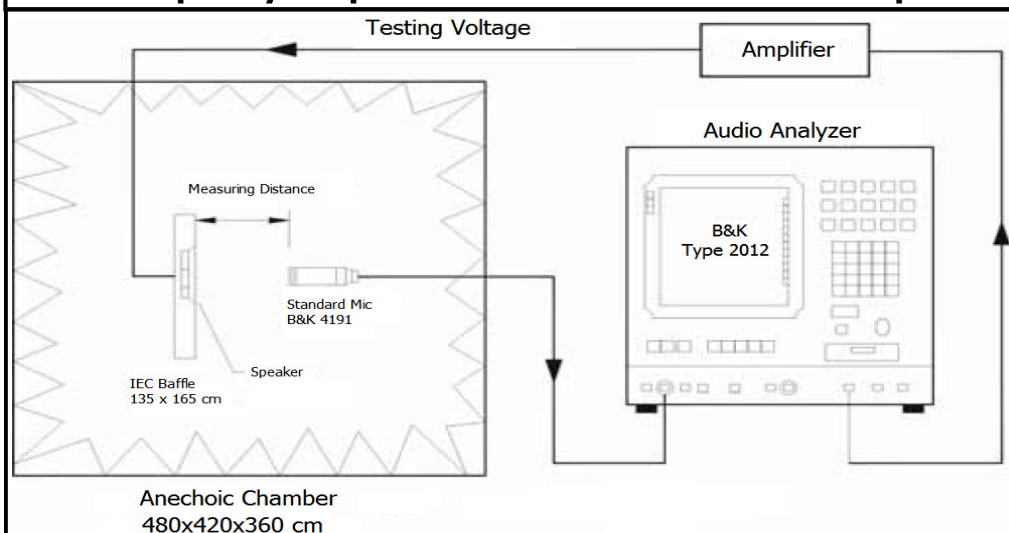

### Thiele-Small Parameters

Specification	Value
<b>Fo (Hz)</b>	380
<b>Qes</b>	3.65
<b>Qms</b>	1.44
<b>Qts</b>	1.03
<b>Vas (mm<sup>3</sup>)</b>	17.32k
<b>Sd (mm<sup>2</sup>)</b>	600
<b>Mms (g)</b>	0.389
<b>Re (ohm)</b>	7.4
<b>BL (T)</b>	1.32

# SPECIFICATIONS

PARAMETERS	VALUES	UNITS
RATED INPUT POWER	2	W
MAX INPUT POWER	4	W
IMPEDANCE	8 ± 15%	OHM
OUTPUT SPL @ 1W/0.5M (AT 1.0, 1.2, 1.5, 2.0 kHz)	84 ± 3	dB
DISTORTION (MAX.)	5%	-
RESONANT FREQUENCY	380 ± 20%	Hz
FREQUENCY RANGE	380 ~ 20,000	Hz
HOUSING MATERIAL	ABS	-
CONE MATERIAL	TREATED PAPER	-
MAGNET MATERIAL	Nd-Fe-B	-
OPERATING TEMPERATURE	-20 ~ +60	°C
WEIGHT	12	grams

THIS DOCUMENT CONTAINS DATA PROPRIETARY TO PROJECTS UNLIMITED, INC. ANY USE OR REPRODUCTION, IN ANY FORM, WITHOUT PRIOR WRITTEN PERMISSION OF PROJECTS UNLIMITED, INC. IS PROHIBITED.  
©2003, Projects Unlimited Inc.

# REVISION HISTORY

LTR	DESCRIPTION	DATE	APPROVED
-	RELEASED FROM ENGINEERING	9/25/2006	
A	REVISED TO INVENTOR 3-D DRAWING TEMPLATE	12/31/2008	B.R.
B	ADDED NOTE 5	8/12/2011	B.R.

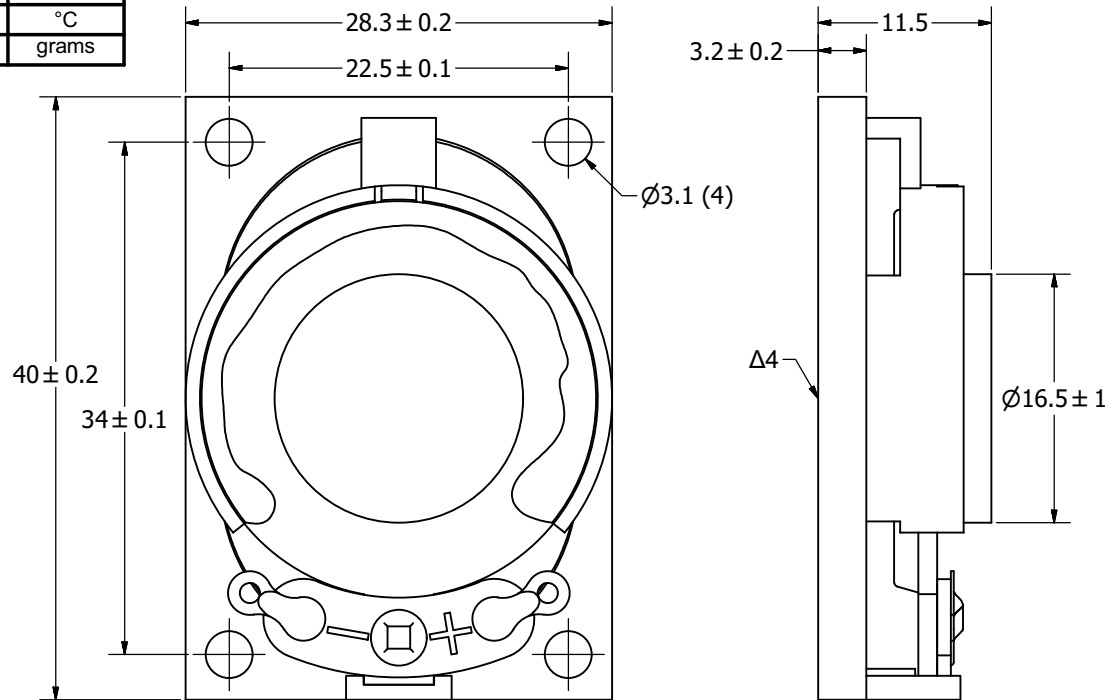

## NOTES:

1. ALL DIMENSIONS ARE IN MILLIMETERS.
2. SPECIFICATIONS SUBJECT TO CHANGE OR WITHDRAWAL WITHOUT NOTICE.
3. THIS PART IS RoHS 2002/95/EC COMPLIANT.
- $\Delta 4$ . CONE HAS BEEN TREATED FOR WATER RESISTANCE.
5. BASE SPEAKER PUI# AS04008PS-4W-R.

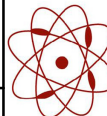
UNLESS OTHERWISE SPECIFIED: DIMENSIONS ARE IN MILLIMETERS, TOLERANCES ARE $\pm 0.5$ AND ANGLES ARE $\pm 3^\circ$ .	SIZE	Designed by	Date	Checked by	Date	Approved by	Date	Drawn Date	
	<b>A3</b>	J.D.	9/25/2006	B.R.	9/25/2006	R.W.	9/25/2006	12/31/2008	
AS04008PS-4W-WR-R.idw		 <b>pui audio</b> <small>a projects unlimited company</small>		<b>AS04008PS-4W-WR-R</b>				Edition - Sheet 1 / 1	
		<b>Speaker</b>							