

∅ **172x51** mm

San Ace 172 9E type   

Round type



General Specifications

- Material Frame: Aluminum, Impeller: Plastic (Flammability: UL 94V-1)
- Expected life See the table below. (L10 life: 90% survival rate for continuous operation in free air at 60°C, rated voltage)
Expected life at 40°C is for reference only.
- Motor protection function Locked rotor burnout protection, Reverse polarity protection
For details, please refer to p. 580.
- Dielectric strength 50/60 Hz, 500 VAC, for 1 minute (between lead wire conductors and frame)
- Insulation resistance 10 MΩ min. at 500 VDC (between lead wire conductors and frame)
- Sound pressure level (SPL) A-weighted sound pressure level (SPL) at 1 m away from the air inlet.
- Storage temperature -30 to +70°C (Non-condensing)
- Lead wire ⊕Red ⊖Black or Blue Sensor Yellow
- Mass 780 g

Specifications

The models listed below **have pulse sensors.**

| Model no. | Rated voltage [V] | Operating voltage range [V] | Rated current [A] | Rated input [W] | Rated speed [min ⁻¹] | Max. airflow [m ³ /min] [CFM] | Max. static pressure [Pa] [inchH ₂ O] | SPL [dB (A)] | Operating temperature [°C] | Expected life [h] |
|-----------------|-------------------|-----------------------------|-------------------|-----------------|----------------------------------|--|--|--------------|----------------------------|----------------------------|
| ▶▶ 109E1712K501 | 12 | 10.2 to 13.8 | 2.9 | 34.8 | 4100 | 8.5 300 | 243.0 0.976 | 55 | -20 to +60 | 40000/60°C (70000/40°C) |
| ▶▶ 109E1712Y501 | | | 2.3 | 27.6 | 3800 | 7.8 276 | 210.0 0.843 | 53 | | |
| ▶▶ 109E1712H501 | | | 1.2 | 14.4 | 3050 | 6.4 226 | 137.2 0.551 | 47 | | |
| ▶▶ 109E1712F501 | | | 0.68 | 10.8 | 2500 | 5.1 180 | 95.0 0.382 | 42 | | |
| ▶▶ 109E1712M501 | 24 | 20.4 to 27.6 | 0.48 | 5.76 | 2000 | 4.2 148 | 67.6 0.271 | 36 | -20 to +70 | |
| ▶▶ 109E1724C501 | | | 2.3 | 55.2 | 4800 | 9.9 350 | 308.0 1.237 | 60 | | |
| ▶▶ 109E1724K501 | | | 1.3 | 31.2 | 4100 | 8.5 300 | 243.0 0.976 | 55 | | |
| ▶▶ 109E1724H501 | | | 0.58 | 13.92 | 3050 | 6.4 226 | 137.2 0.551 | 47 | | |
| ▶▶ 109E1724F501 | 48 | 40.8 to 55.2 | 0.35 | 8.4 | 2500 | 5.1 180 | 95 0.382 | 42 | -20 to +60 | |
| ▶▶ 109E1724M501 | | | 0.2 | 4.8 | 2000 | 4.2 148 | 67.6 0.271 | 36 | | |
| ▶▶ 109E1748C501 | | | 1.2 | 57.6 | 4800 | 9.9 350 | 308.0 1.237 | 60 | | |
| ▶▶ 109E1748K501 | | | 0.7 | 33.6 | 4100 | 8.5 300 | 243.0 0.976 | 55 | | |
| ▶▶ 109E1748H501 | 48 | 40.8 to 55.2 | 0.28 | 13.44 | 3050 | 6.4 226 | 137.2 0.551 | 47 | -20 to +70 | |
| ▶▶ 109E1748F501 | | | 0.19 | 9.12 | 2500 | 5.1 180 | 95 0.382 | 42 | -20 to +60 | |
| ▶▶ 109E1748M501 | | | 0.11 | 5.28 | 2000 | 4.2 148 | 67.6 0.271 | 36 | -20 to +70 | |

Note 1: Sensor and control options are available for selection. Refer to the table on p. 602.
 Note 2: The ▶▶ mark indicates Short LeadTime Service applicable models. See p. 630 for details.

Airflow - Static Pressure Characteristics

109E1712K501 With pulse sensor

Operating voltage range

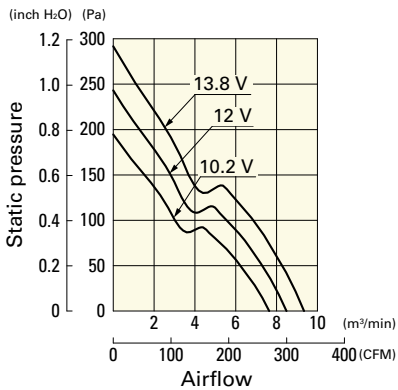

109E1712Y501 With pulse sensor

Operating voltage range

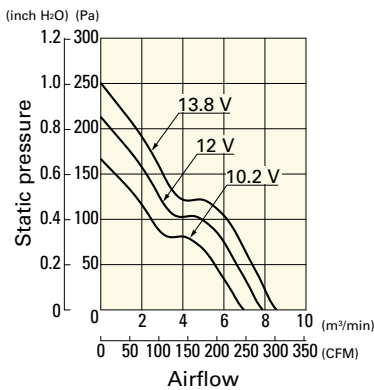

109E1712H501 With pulse sensor

Operating voltage range

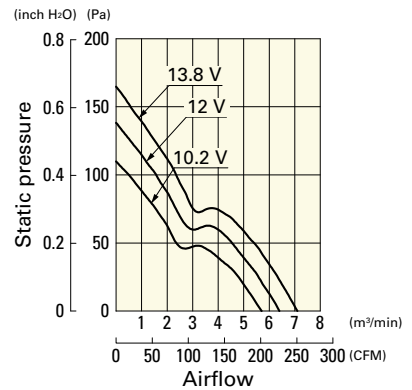

Airflow - Static Pressure Characteristics

109E1712F501 With pulse sensor

Operating voltage range

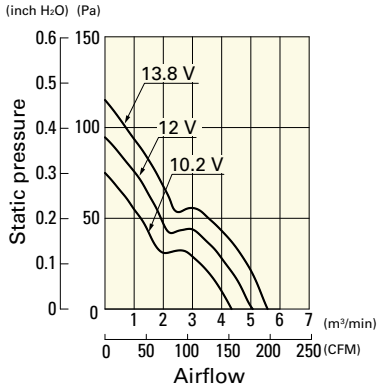

109E1712M501 With pulse sensor

Operating voltage range

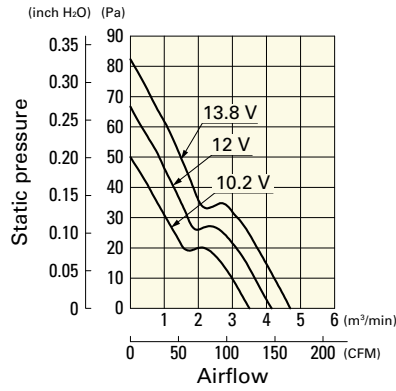

109E1724C501 With pulse sensor

Operating voltage range

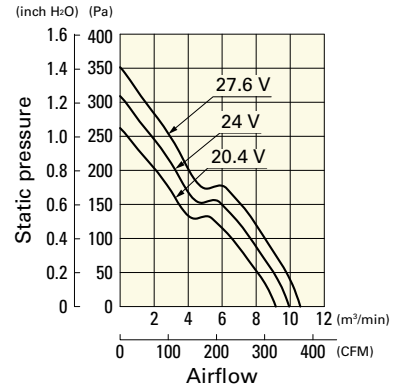

109E1724K501 With pulse sensor

Operating voltage range

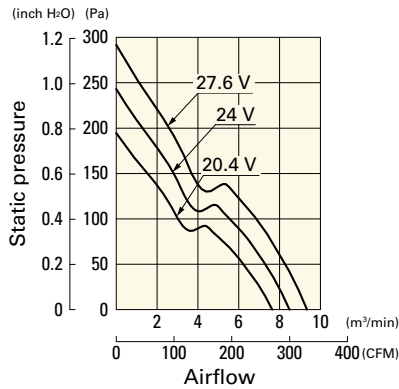

109E1724H501 With pulse sensor

Operating voltage range

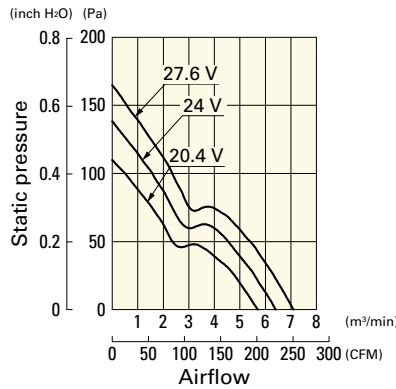

109E1724F501 With pulse sensor

Operating voltage range

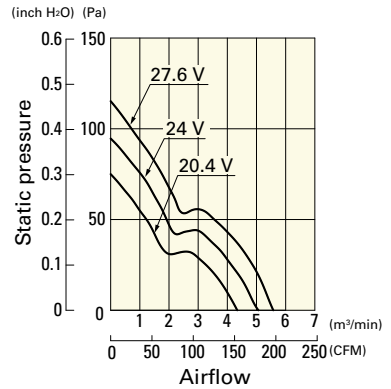

109E1724M501 With pulse sensor

Operating voltage range

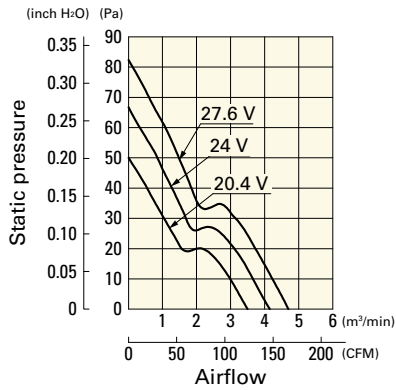

109E1748C501 With pulse sensor

Operating voltage range

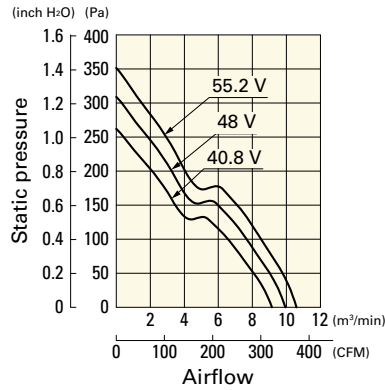

109E1748K501 With pulse sensor

Operating voltage range

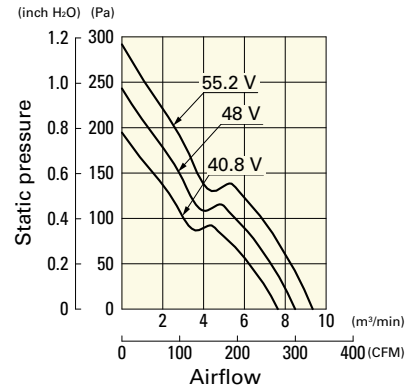

109E1748H501 With pulse sensor

Operating voltage range

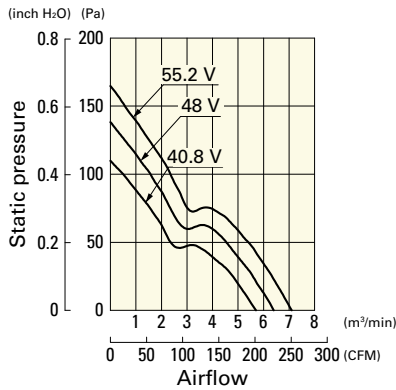

109E1748F501 With pulse sensor

Operating voltage range

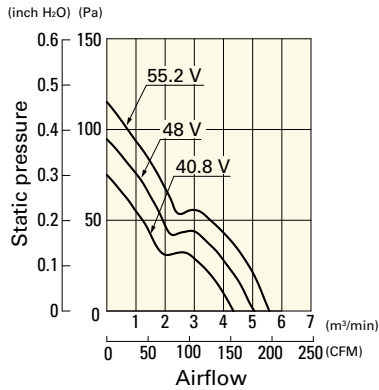

109E1748M501 With pulse sensor

Operating voltage range

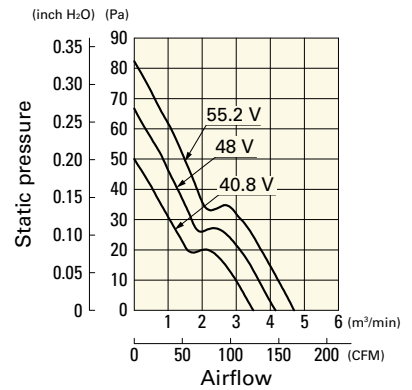

Dimensions (unit: mm)

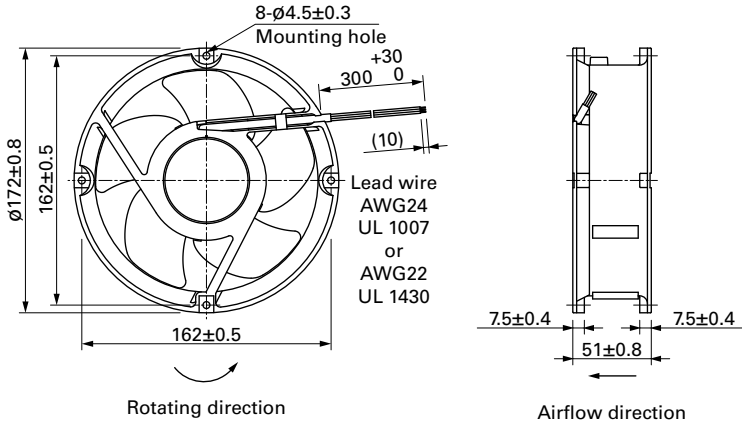

Reference Dimensions of Mounting Holes and Vent Opening (unit: mm)

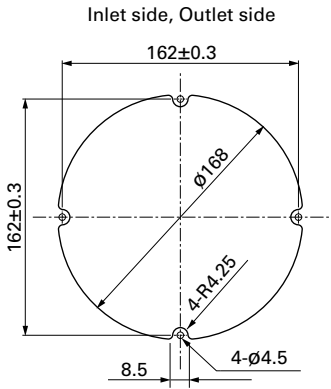

Options

Finger guards

page: p. 566

Model no.: 109-319E, 109-319H, 109-320, 109-1066, 109-1068