

DC Fan

∅172x150x51 mm



San Ace 172 9E type

Sidecut type

General Specifications

- Material Frame: Aluminum, Impeller: Plastic (Flammability: UL 94V-1)
- Expected life See the table below. (L10 life: 90% survival rate for continuous operation in free air at 60°C, rated voltage)
Expected life at 40°C is for reference only.
- Motor protection function Locked rotor burnout protection, Reverse polarity protection
For details, please refer to p. 580.
- Dielectric strength 50/60 Hz, 500 VAC, for 1 minute (between lead wire conductors and frame)
- Insulation resistance 10 MΩ min. at 500 VDC (between lead wire conductors and frame)
- Sound pressure level (SPL) A-weighted sound pressure level (SPL) at 1 m away from the air inlet.
- Storage temperature -30 to +70°C (Non-condensing)
- Lead wire ⊕Red ⊖Black or Blue Sensor Yellow
- Mass 760 g

Specifications

The models listed below **have pulse sensors**.

Model no.	Rated voltage [V]	Operating voltage range [V]	Rated current [A]	Rated input [W]	Rated speed [min ⁻¹]	Max. airflow [m ³ /min] [CFM]	Max. static pressure [Pa] [inchH ₂ O]	SPL [dB (A)]	Operating temperature [°C]	Expected life [h]
▶▶ 109E5712K501	12	10.2 to 13.8	2.9	34.8	4100	8.5 300	243.0 0.976	60	-20 to +60	40000/60°C (70000/40°C)
▶▶ 109E5712Y501			2.3	27.6	3800	8 282	210 0.84	60		
▶▶ 109E5712H501			1.2	14.4	3050	6.4 226	137.2 0.551	52		
▶▶ 109E5712F501			0.68	8.16	2500	5.1 180	95 0.38	47		
▶▶ 109E5712M501			0.48	5.76	2000	4.2 148	67.6 0.271	41		
▶▶ 109E5724C501	24	20.4 to 27.6	2.3	55.2	4800	9.9 350	308.0 1.237	66	-20 to +70	
▶▶ 109E5724K501			1.3	31.2	4100	8.5 300	243.0 0.976	60		
▶▶ 109E5724H501			0.58	13.92	3050	6.4 226	137.2 0.551	52		
▶▶ 109E5724F501			0.35	8.4	2500	5.1 180	95 0.38	47		
▶▶ 109E5724M501			0.2	4.8	2000	4.2 148	67.6 0.271	41		
▶▶ 109E5748C501	48	40.8 to 55.2	1.2	57.6	4800	9.9 350	308.0 1.237	66	-20 to +60	
▶▶ 109E5748K501			0.7	33.6	4100	8.5 300	243.0 0.976	60		
▶▶ 109E5748H501			0.28	13.44	3050	6.4 226	137.2 0.551	52	-20 to +70	
▶▶ 109E5748F501			0.19	9.12	2500	5.1 180	95 0.38	47		
▶▶ 109E5748M501			0.11	5.28	2000	4.2 148	67.6 0.271	41		

Note 1: Sensor and control options are available for selection. Refer to the table on p. 603.

Note 2: The ▶▶ mark indicates Short LeadTime Service applicable models. See p. 630 for details.

Airflow - Static Pressure Characteristics

109E5712K501 With pulse sensor

Operating voltage range

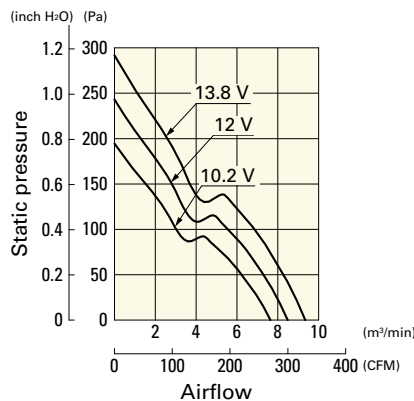

109E5712Y501 With pulse sensor

Operating voltage range

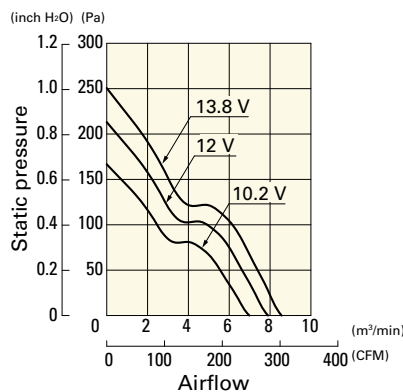

109E5712H501 With pulse sensor

Operating voltage range

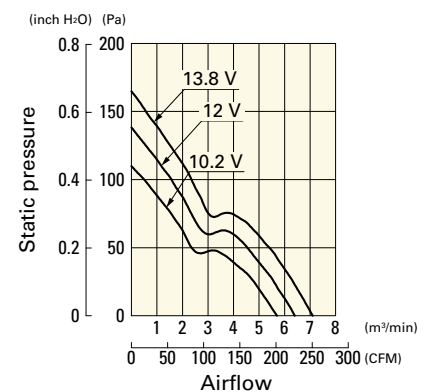

Airflow - Static Pressure Characteristics

109E5712F501 With pulse sensor

Operating voltage range

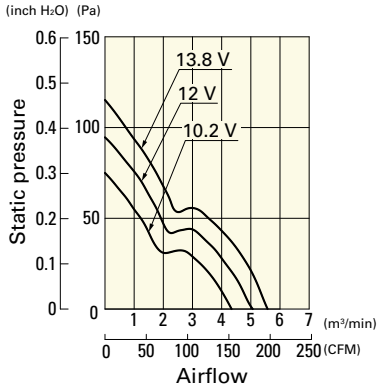

109E5712M501 With pulse sensor

Operating voltage range

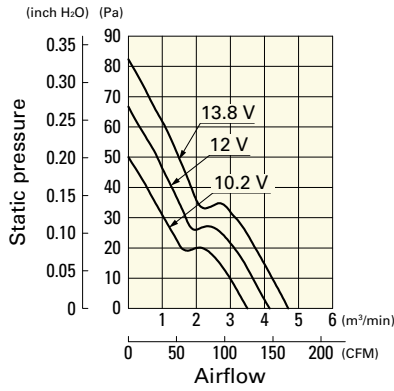

109E5724C501 With pulse sensor

Operating voltage range

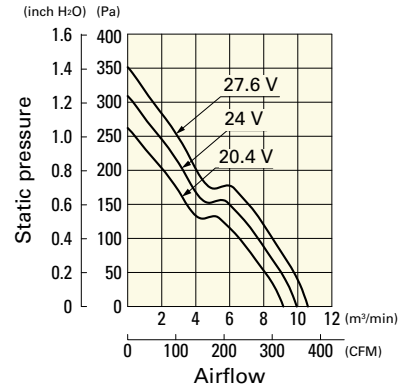

109E5724K501 With pulse sensor

Operating voltage range

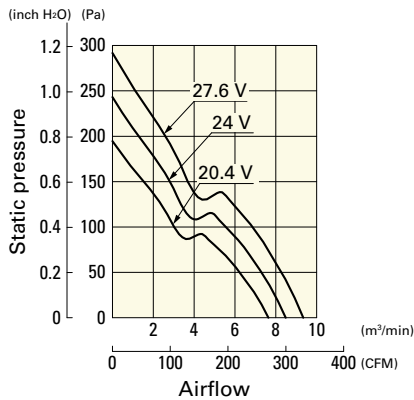

109E5724H501 With pulse sensor

Operating voltage range

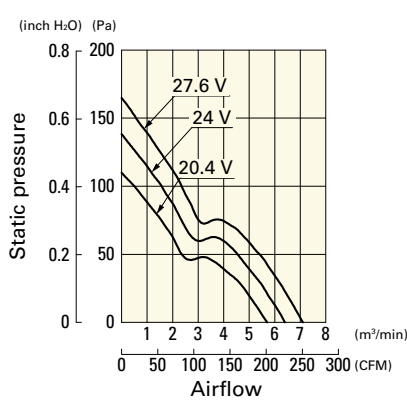

109E5724F501 With pulse sensor

Operating voltage range

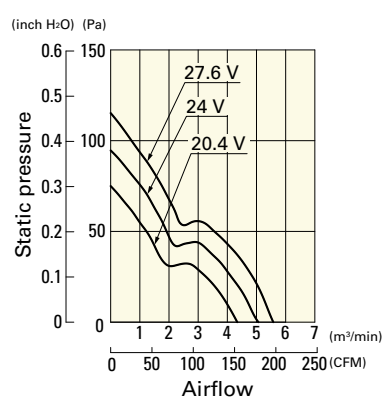

109E5724M501 With pulse sensor

Operating voltage range

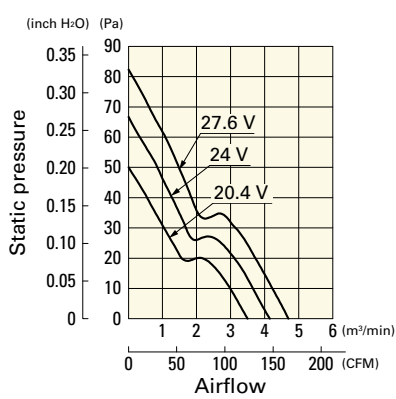

109E5748C501 With pulse sensor

Operating voltage range

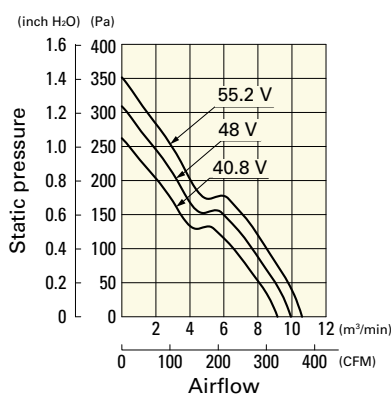

109E5748K501 With pulse sensor

Operating voltage range

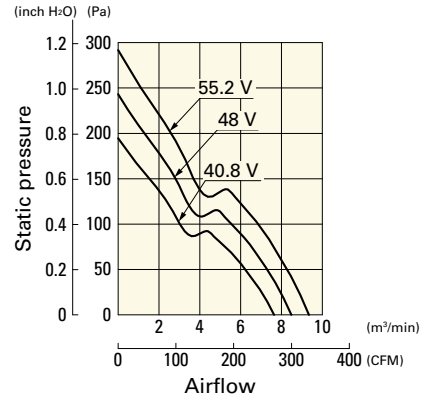

109E5748H501 With pulse sensor

Operating voltage range

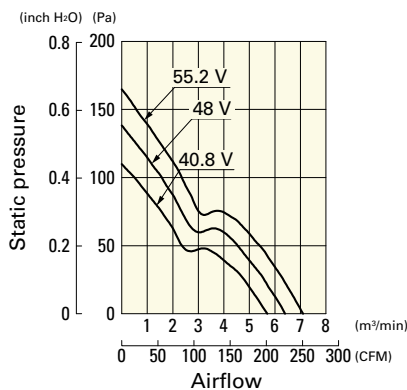

109E5748F501 With pulse sensor

Operating voltage range

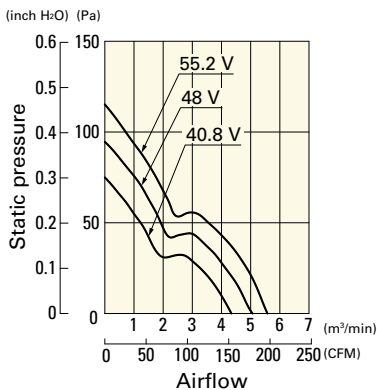

109E5748M501 With pulse sensor

Operating voltage range

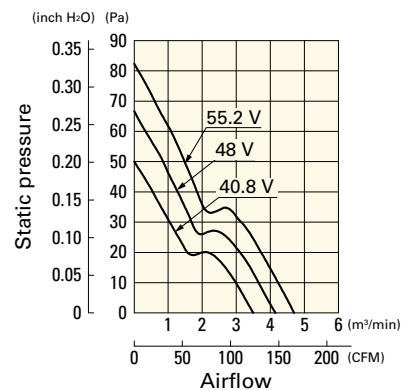

Dimensions (unit: mm)

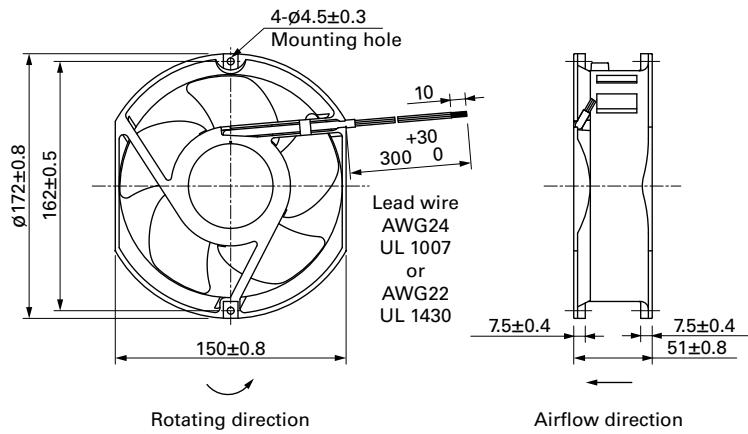

Reference Dimensions of Mounting Holes and Vent Opening (unit: mm)

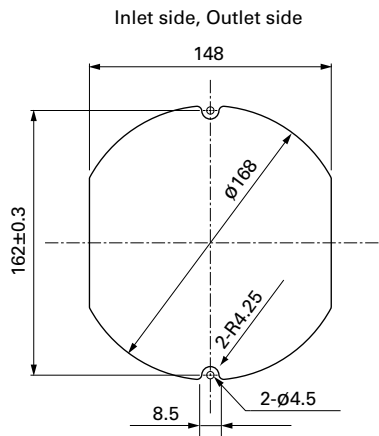

Options

Finger guards

page: p. 566

Model no.: 109-319E, 109-319H, 109-320